



Oregon Department of Forestry
 2600 State St Salem OR 97310

PART III: EXHIBITS

EXHIBIT B

TIMBER SALE OPERATIONS PLAN

(See page 2 for instructions)

Date Received by State: _____

(5) State Brand Information (Complete)

(1) Contract Number: TL-341-2023-W00848-01

(2) Sale Name: Lobo Canyon

(3) Contract Expiration Date: 10/31/2025

(4) Purchaser Name: _____

(6) State Representatives:

<u>Name</u>	<u>Circle One</u>	<u>Phone No.</u>	<u>Cell No.</u>	<u>Alt Phone</u>
	Logging Projects All			
	Logging Projects All			
	Logging Projects All			
	Logging Projects All			

(7) Purchaser Representatives:

<u>Name</u>	<u>Circle One</u>	<u>Phone No.</u>	<u>Cell No.</u>	<u>Alt Phone</u>
	Logging Projects All			
	Logging Projects All			
	Logging Projects All			
	Logging Projects All			
	Logging Projects All			
	Logging Projects All			
	Logging Projects All			

(8) Name of Subcontractors and Start Dates:

<u>Project No.</u>	<u>Subcontractor Name.</u>	<u>Start Date</u>	<u>Completion Date</u>	<u>Cell No.</u>	<u>Alt Phone</u>

Subcontractor Name. Start Date Cell No. Alt Phone

(9) Comments:

(10) Operations Map: Attach a copy of timber sale Exhibit A or other suitable map which plainly shows the items listed on the instruction sheet.



Oregon Department of Forestry

2600 State St Salem OR 97310

PART III: EXHIBITS

EXHIBIT B





INSTRUCTION SHEET FOR OPERATIONS PLAN

SUBMIT ONE COPY OF PLAN STATE

Operations shall be limited to the work shown in the plan until a revised plan or supplemental plan is submitted covering additional work. Compliance with this plan is not in lieu of compliance with any federal requirements related to the federal Endangered Species Act. If STATE has prepared a required Forest Practices Act (FPA) "Written Plan" for operations, PURCHASER shall comply with all provisions of the Written Plan.

Explanation of Item No.(from Page 1)

- (5) All sales require you to use a brand furnished by STATE. If the State brand has not been assigned when the plan is submitted, it will be furnished and assigned later. Complete drawing. If more than one brand is assigned to the sale, complete both drawings.
- (6) The contract requires you to have a designated representative available on the sale area or work location who is authorized to receive in your behalf any notice or instruction given by STATE and to take action in regard to performance under the contract. If logging and project work is widely separated, a representative is required for each.
- (7) The STATE representative will be designated when your plan is approved and is the person who will inspect and issue instructions regarding performance.
- (8) Show names of subcontractors to be used for any or all phases of the operations. If subcontractors are not Known, or are changed later, give notification to the STATE representative prior to commencement of work by subcontractor.
- (9) Show projected dates for commencement of both projects and logging. If projected dates need to be changed at a later date, notification must be given to the STATE representative by supplemental plan or otherwise, prior to commencement of such operations.
- (10) The STATE representative will furnish extra copies of Exhibit A of the contract for your use in preparing the operations map. The map shall use the following legend and show:
1. Landing locations, approximate setting boundaries, and probable sequence of logging the settings. Number the settings in sequence.
 2. Locations of spur roads planned for construction, other than required by the timber sale contract. Provide spur road specifications
 3. Locations of proposed tractor yarding roads. Show if and how marked on the ground.
 4. Locations of temporary stream crossings.
 5. List the sequence of performing project work.
 6. Location of rock sources - attach pit development plans.

	1	Cable Landing, with numbers for sequence.
	A	Tractor Landing with alphabetical sequence.
		Approximate setting boundary.
		Spur truck roads.
		Tractor yarding roads.
X		Temporary stream crossings.



Oregon Department of Forestry
 2600 State St Salem OR 97310
 PART III: EXHIBITS
EXHIBIT B
OPERATIONS PLAN

Completion Timeline

Indicate on the appropriate timeline below, the dates by which you plan to complete the work as required under this contract. The purpose of this section is to develop a plan that will ensure you complete the work as required, and meet the interim completion date(s) and contract expiration date. This plan is incorporated and made a part of the contract. When, in the opinion of STATE, operations are not commencing in a manner that meets the intent of this plan, you may be placed in violation of contract and your operations suspended until an amended plan is submitted and approved by STATE.

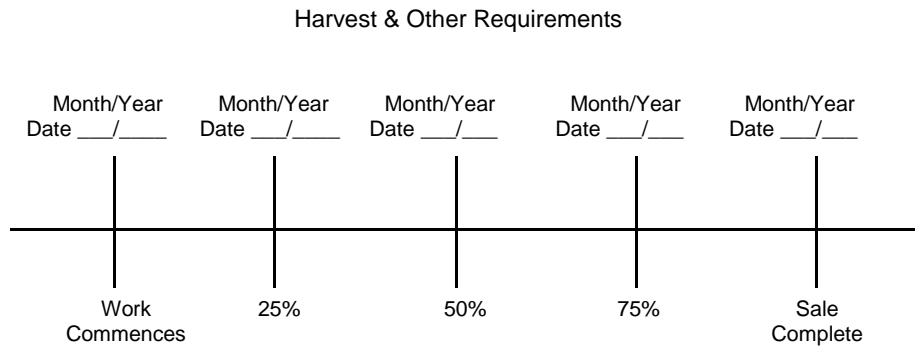
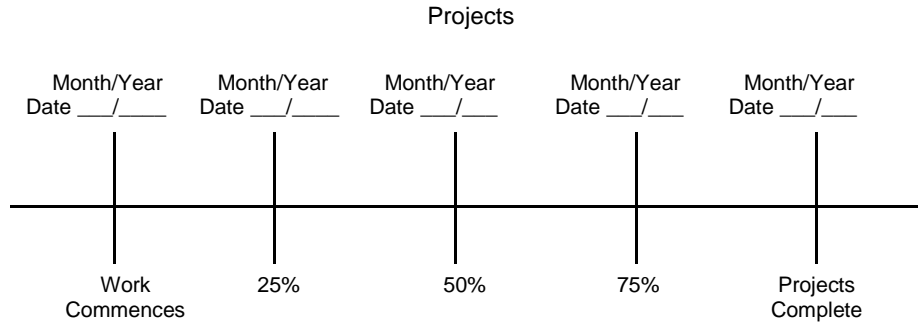

The Federal Endangered Species Act (ESA) prohibits a person from taking any federally listed threatened or endangered species. Taking under the federal ESA may include alteration of habitat. STATE's approval of this plan does not certify that PURCHASER's operation under the plan is lawful under the federal ESA. As provided in the timber sale contract, PURCHASER's must comply with all applicable state, federal, and local laws.

PURCHASER's compliance with this plan is not in lieu of compliance with any federal requirements related to the federal Endangered Species Act.

APPROVED; Date: _____

SUBMITTED BY:
PURCHASER

STATE OF OREGON - DEPARTMENT OF
FORESTRY

Title _____

Title _____



Oregon Department of Forestry
EXHIBIT C - SAWMILL GRADE (WESTSIDE SCALE)
SCALING INSTRUCTIONS - LOCATION APPROVAL - BRAND INFORMATION
Tillamook - NWOA

(1) ORIGINAL REGISTRATION Date _____
 REVISION NUMBER 000 Date _____
 CANCELLATION Date _____

(2) TO: _____
 (Third Party Scaling Organization)

(3) FROM: Tillamook Phone (503) 842-2545
 (State Forestry District)

Address: 5005 THIRD ST
 TILLAMOOK, OR 97141-2999

(4) PURCHASER: _____
 Mailing Address: _____

Phone Number: _____

(5) MINIMUM SCALING SPECIFICATIONS	
SPECIES	MINIMUM NET VOLUME
Conifers	10
Hardwoods	10

*Apply minimum volume test to whole logs over 40' Westside

(6) WESTSIDE SCALE:
 Use Region 6 actual taper rule. Logs over 40'.

(7) Weight Scale Sample YES NO

(8) APPROVED SCALING LOCATIONS (as shown on the ODF Approved Locations web-site)	Species	Yard	Truck	Weight

(9) SALE NAME: Lobo Canyon
 COUNTY: Tillamook

(10) STATE CONTRACT NUMBER:
TL-341-2023-W00848-01

(11) STATE BRAND REGISTRATION NUMBER:

(12) STATE BRAND INFORMATION:

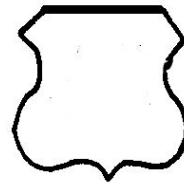

(13) PAINT REQUIRED: YES
 COLOR: Orange

(14) SPECIAL REQUESTS	(Check applicable)
PEELABLE CULL (all species).....	<input type="checkbox"/>
NO DEDUCTIONS ALLOWED FOR MECHANICAL DAMAGE	<input checked="" type="checkbox"/>
ADD-BACK VOLUME - Deductions due to delay...	<input checked="" type="checkbox"/>
OTHER :	

(15) REMARKS:

Operator's Name (Optional inclusion by District): _____

(16) _____

 Purchaser or Authorized Representative Date

 State Forester Representative Date

 State Forester Representative PRINT NAME

Notify the District within one hour when branding or painting is inadequate for quick identification, the receipts are missing, not correctly or completely filled out, and/or when logs presented for scaling are impossible to scale accurately.



Oregon Department of Forestry
EXHIBIT C - SAWMILL GRADE
INSTRUCTIONS FOR EXHIBIT C
Tillamook - NWOA

(1) Check appropriate box. REVISION NUMBER requires comments. CANCELLATION requires logging and hauling to be complete, recall branding hammers.

(2)

Columbia River Log Scaling & Grading Bureau
P.O.Box 7002, Eugene, OR 97401
Phone: (541) 342-6007 Fax: (541) 342-2631
Email: services@crls.com

Pacific Rim Log Scaling Bureau, Inc.
8288 28th Court North East, Lacey, WA 98516
Phone: (360) 528-8710 Fax: (360) 528-8718
Email: office@prlsb.com

Mountain Western Log Scaling & Grading Bureau
P.O.Box 580, Roseburg, OR 97470
Phone: (541) 673-5571 Fax: (541) 672-6381
Email: info@mwlsgb.com

Yamhill Log Scaling & Grading Bureau
P.O.Box 709, Forest Grove, OR 97116
Phone: (503) 359-4474 Fax: (503) 359-4476
Email: yamhilllog@frontier.com

Northwest Log Scalars Inc.
6137 NE 63rd St, Vancouver, WA, 98661
Phone: (360) 553-7212 ext. 4 Fax:(360) 553-7213
Email: info@nwlogscalars.com

(3) State District office, address and phone.

(4) Enter Purchaser's business name, address, and phone number as it appears on the Contract.

(5) Minimum Scaling Specifications.

(6) Westside - Region 6 actual taper segment scale. Check Yes or No. Special Service Rules on file with TPSO. See: Segment Scaling and Grading of Long Logs - All Species - State Forestry Department Scaling Practices (Westside).

(7) Weight Scale Sample - Check box if sale is to be a Weight Scale Sample. All specifics for handling, scaling and processing will be attached or explained in the Remarks section item (15).

(8) Show scaling locations only applicable to TPSO. Location name should appear as it does on the ODF Approved Scaling Location web site: https://apps.odf.oregon.gov/Divisions/management/asset_management/scalinglocation.asp Locations with scaling and processing directions specific to their location should be on a separate form. Species should be identified if not capable of receiving "all" species. Check appropriate box for either: yard, truck scale, or weight. Refer to the web site listed above for the locations approval status.

(9) Enter sale name and county.

(10) Enter sale Contract number.

(11) Enter Oregon's State Brand Registry Number (**REQUIRED**).

(12) Show brand assigned to timber sale. One brand only. If more than one brand is assigned to the sale: (1) make a separate form for each brand and (2) on each form, explain and show other brand(s) in the Remarks section item (15).

(13) Check yes for Paint Required and designate "Orange" for color. Non required removal volumes may sometimes require blue paint.

(14) Special Requests. These are requests that will be applied to ODF timber sales. All boxes applicable to the timber sales designated in the Exhibit C form must be "marked". If "Other" is indicated, it must contain a description and any necessary comments.

(15) Use this space to designate any weight scale sample instructions or any other explanations to clarify scaling, processing and/or mailing requirements. If additional scaling locations are approved, revise original or current form showing all (old and new) locations. Check REVISION box at top of form and explain under remarks. Route as indicated.

(16) Require purchaser to sign and date completed form in addition to State Forester Representative, sign and print name on the form. Signatures not required on revisions.



**Oregon Department of Forestry
 EXHIBIT C - PULP SORT
 PROCESSING INSTRUCTIONS - LOCATION APPROVAL
 BRAND INFORMATION**

Tillamook, NWOA

(1) ORIGINAL REGISTRATION Date _____
 REVISION NUMBER 000 Date _____
 CANCELLATION _____

(2) _____

(Approved Pulp Processing Facility)

(3) FROM: Tillamook Phone (503) 842-2545
 (State Forestry District)
 Address: 5005 THIRD ST
TILLAMOOK, OR 97141-2999

(4) PURCHASER: _____

(5) Scaling Bureau (TPSO) Processing Weight receipts:

Mailing Address: _____

Phone Number: _____

(9) SALE NAME: Lobo Canyon

COUNTY: Tillamook

STATE CONTRACT NUMBER: _____

TL-341-2023-W00848-01

(11) STATE BRAND REGISTRATION NUMBER: _____

(12) STATE BRAND INFORMATION: _____

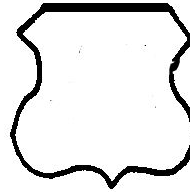

(13) REMARKS:

Operator's Name (Optional inclusion by District):

(14) SIGNATURES:

Purchaser or Authorized Representative Date

State Forester Representative Date

State Forester Representative PRINT NAME

(6) **STATE Definition of Approved Pulp Sort:**

- Top portion of the tree (tops).
- All logs with a diameter (Big End) greater than 8 inches marked with blue paint.

(7) PULP FACILITY PROCESSING INSTRUCTIONS:

- Pulp loads shall be weighed in lieu of scaling.
- One Ton = 2000 lbs (Short Ton).
- Pulp loads shall have a yellow Log Load Receipt attached.
- Gross weight and truck tare weight for each load shall be machine printed on the weight receipt.
- Weigher shall sign the weight receipt.
- Weigher shall record the Log Load Receipt number on the weight receipt.
- Weigher shall attach the Weight receipt to the Log Load Receipt and mail them weekly to the TPSO processing the Weight receipt.

(8) TPSO PROCESSING INSTRUCTIONS

- Submit data files daily (or each day of activity).
- Mail or deliver scale tickets weekly to ODF Headquarters in Salem.

Notify the District within one hour when branding is inadequate for quick identification, the logs are marked with orange paint, the receipts are missing, not correctly or completely filled out, and/or logs do not meet the specifications of the STATE definition of Approved Pulp Sort.

General Distribution: TPSO, Approved Scaling Locations and Purchaser.



Oregon Department of Forestry EXHIBIT C - PULP SORT INSTRUCTIONS FOR EXHIBIT C

Tillamook, NWOA

- (1) Check appropriate box. REVISION NUMBER requires comments. CANCELLATION requires logging and hauling to be complete, recall branding hammers.
- (2) Approved Pulp Processing Facility. Write in as written in the Approved Log Delivery Location https://apps.odf.oregon.gov/Divisions/management/asset_management/scalinglocation.asp
- (3) State District office, address and phone.
- (4) Enter Purchaser's business name, address, and phone number as it appears on the Contract.
- (5) Third Party Scaling Organization that will be processing the weight tickets, mailing address, and phone number.

Columbia River Log Scaling & Grading Bureau
P.O.Box 7002, Eugene, OR 97401
Phone: (541) 342-6007 Fax: (541) 342-2631
Email: services@crls.com

Pacific Rim Log Scaling Bureau, Inc.
8288 28th Court North East, Lacey, WA 98516
Phone: (360) 528-8710 Fax: (360) 528-8718
Email: office@prlsb.com

Mountain Western Log Scaling & Grading Bureau
P.O.Box 580, Roseburg, OR 97470
Phone: (541) 673-5571 Fax: (541) 672-6381
Email: info@mwlsgb.com

Yamhill Log Scaling & Grading Bureau
P.O.Box 709, Forest Grove, OR 97116
Phone: (503) 359-4474 Fax: (503) 359-4476
Email: yamhilllog@frontier.com

Northwest Log Scalers Inc.
6137 NE 63rd St, Vancouver, WA, 98661
Phone: (360) 553-7212 ext. 4 Fax:(360) 553-7213
Email: info@nwlogscalers.com

Big end of log is not to exceed 2 inches greater than the minimum removal specifications in the contract. Example: Minimum removal specifications 6 inches and 20 board feet, then the Big end of log not to exceed 8 inches. When conifer and hardwood removal specifications are different, use the smaller removal diameter to determine this specification.

- (9) Enter sale name and county.
- (10) Enter sale Contract number.
- (11) Enter Oregon's State Brand Registry Number **(REQUIRED)**.
- (12) Show brand assigned to timber sale. One brand only, if more than one brand is assigned to the sale: (1) make a separate form for each brand and (2) on each form, explain and show other brand(s) in the Remarks section Item (13).
- (13) Use this section to list any special instructions or the reason for any revisions in section item (1).
- (14) Require purchaser to sign and date completed form in addition to State Forester Representative, sign and print name on the form. Signatures not required on revisions.

EXHIBIT D

FOREST ROAD SPECIFICATIONS

POINT TO POINT	STATION TO STATION	SUBGRADE WIDTH (feet)	SURFACE WIDTH (feet)	DRAINAGE	DITCH SHAPE	DITCH DEMINSIONS (WIDTH X DEPTH) (feet)
A to B	0+00 to 222+85	-	12	Existing	V	3X1
C to D	0+00 to 30+60	-	12	Ditch	V	3X1
C to D	30+60 to 111+15	-	12	Existing	V	2X1
E to F	0+00 to 6+00	16	12	Outslope	-	-
G to H	0+00 to 5+15	16	12	Outslope	-	-
I to J	0+00 to 10+60	16	12	Ditch	V	3X1
K to L	0+00 to 1+30	16	12	Outslope	-	-
M to N	0+00 to 1+45	16	12	Outslope	-	-
O to P	0+00 to 8+65	-	12	Outslope	-	-
Q to R	0+00 to 4+70	16	12	Outslope	-	-
S to T*	0+00 to 114+95	-	12	Existing	V	2X1
U to V	0+00 to 21+35	18	14	Ditch	V	3X1

*No grading, shaping, or compacting is required.

CLEARING. This work shall consist of clearing, removing, and disposing of all trees, snags, down timber, brush, surface objects, and protruding obstructions within the clearing limits. Trees outside the clearing limits shall not be felled unless approved in writing by STATE. All danger trees, leaners, and snags outside the clearing limits which could fall and hit the road shall be felled. Where clearing limits have not been marked, clearing limits shall be as follows:

- New construction – 10 feet back from the top of the cut slope and 5 feet back from the toe of fill slopes.
- Improvements and reconstructions - 10 feet back from the shoulder of the subgrade or the ditch, whichever is widest.

GRUBBING. This work shall consist of the removal or digging out of stumps and protruding objects. All stumps shall be completely removed within the limits of required grubbing. Stumps overhanging cutslopes shall be removed. Grubbing limits shall be as follows:

- New construction - From the top of the cutslope to the toe of the fill.
- Improvements and reconstructions - 4 feet back from the shoulder of the subgrade or the ditch, whichever is widest.
- Sidecast pullback – From top of pullback to toe of pullback.

CLEARING AND GRUBBING DISPOSAL. Clearing and grubbing debris shall not be placed or permitted to remain in or under any road embankment sections. Clearing and grubbing debris shall not be left lodged against standing trees. Clearing and grubbing debris may be scattered through openings in the timber outside of the cleared right-of-way, except for the following areas where debris shall be fully contained and hauled to a designated waste area:

- Where end-haul is required
- On side slopes exceeding 55 percent
- On unstable areas
- In any stream channel (Type F, N or D) or where material may enter the stream channel.

EXHIBIT D

FOREST ROAD SPECIFICATIONS

Clearing, grubbing, and associated disposal shall be completed prior to subgrade approval.

EXCAVATION. Excavation and grading shall not be done when weather and/or ground conditions are such that damage will result to existing subgrade or cause excessive erosion.

Excavation shall conform to STATE-specified lines, grades, dimensions, and plans when provided.

Suitable excavated material shall be used for the formation of fills, shoulders, and drainage structure backfills. Embankment materials shall be free of woody debris, brush, muck, sod, frozen material, and other deleterious materials. All fills and drainage structure backfills shall be machine compacted according to the "Compaction and Processing Requirements" in Exhibit E.

Unless road plans show otherwise, all roads shall be on a balanced cross section, except when the slope is over 55 percent, the road shall be on full bench for the width specified.

Sidecast includes any road generated excess excavation material which is not essential as part of the road prism, is not compacted, and is below the roadway. Sidecast shall not be placed where it will enter a stream course or where material will accumulate in areas deemed a high landslide hazard location by STATE. Leaving sidecast below the road is only permissible if specifically allowed in "Full Bench and End Haul Requirements" in this Exhibit.

All bank excavation and sidecast pullback on a project road segment shall be completed prior to subgrade approval.

ROAD WIDTH LIMITATIONS. PURCHASER shall obtain advance written approval from STATE to construct the road to a greater width than specified. Extra subgrade width shall be required for:

Fill Widening. Add to each fill shoulder 1 foot for fills 3 feet to 6 feet high; 2 feet for fills over 6 feet high.

Curve Widening. Widen the inside shoulder of all curves as specified in the road plans or as follows: 400 divided by the radius of the curve equals the amount of extra width.

DRAINAGE

Ditch. Construct ditch as specified in Exhibit D. Subgrade shall be crowned at 4 to 6 percent. Construct ditchouts away from subgrade at locations marked in the field or as directed by STATE.

Outslope. Road subgrade shall be outsloped at 4 to 6 percent.

Existing. Road subgrade and drainage shall be maintained in its current configuration, outsloped where outsloped, and ditched where ditched

TURNOUTS. Increase roadbed width an additional 8 feet for both subgrade and surfacing. Length shall be at least 25 feet, or as staked on the ground, plus 25-foot approaches at each end.

Location: Intervisible but not greater than 750 feet apart.

SLOPES

Rock
Common

Back Slopes
Vertical to 1/4 :1
3/4 :1

Fill Slopes
Not Steeper
Than 1 1/2: 1

Top of cutslopes shall be rounded.

LANDINGS. Landings shall be constructed as posted in the field, no less than 50 feet wide and no more than 70 feet wide unless otherwise approved by STATE. Surface is to be crowned for drainage with general grade no more than 4 percent and no less than 2 percent. All cuts shall be ditched.

TURNAROUNDS. Increase subgrade width an additional 30 feet for a length of 16 feet with 20' radius returns at locations marked in the field.

SEASONAL WINTERIZATION. All unsurfaced roads or unfinished subgrades shall be waterbarred in accordance with the specifications in Exhibit I, and blocked from vehicular traffic prior to October 31, annually and as directed by STATE.

EXHIBIT D
FOREST ROAD SPECIFICATIONS
ADDITIONAL ROAD INSTRUCTIONS

A to B: Replace worn or torn rubber water diverters at the following locations and in accordance with Exhibit K: 108+80, 121+95, 142+80, 145+20, and 146+90.

Replace 5 missing carsonite rubber water diverter markers in accordance with Exhibit K. Clean all rubber water diverters and ditchouts to allow flow of water, as directed by State.

Remove ravel from road edge as marked in the field and as directed by State. Haul material to designated waste area, spread and compact.

From Station	To Station	Distance Into Cutbank(ft)
118+30	119+30	2
153+40	154+90	2
173+00	173+95	3
180+30	181+30	2
184+55	185+30	2
190+60	192+35	2
200+95	202+10	2
210+20	211+90	2
215+20	216+35	2

Remove ravel from road edge as marked in the field and as directed by State. Haul material to designated waste area, spread and compact.

Station	Amount(cy)
155+70	10
178+25	10
183+20	10
186+65	20

Clean ditchout at station 131+85.

C to D: Construct or clean existing ditches with an excavator between the following road stations to meet the specifications in Exhibit D. Endhaul material to designated waste area, spread and compact.

83+65 to 87+95	89+85 to 90+75	91+85 to 92+80	96+70 to 97+25	102+40 to 103+20
106+20 to 111+15				

Construct or clean existing ditches with an excavator between the following road stations to meet the specifications in Exhibit D, spread and compact.

0+40 to 1+70	0+40 to 9+60	6+00 to 15+60	11+20 to 12+10	13+80 to 18+60
16+30 to 18+20	19+75 to 30+60	22+10 to 23+00		

Excavate material in erosion control areas as directed by State and as marked in the field. Replace material with indicated jawrun rock.

From Station	Remove(yds)	Backfill(yds)
97+25	15	10
107+35	20	10

Clean culverts and install approximately 4 culvert markers at culvert locations where markers are missing or damaged. Repair downspout at station 75+25.

Remove ravel from road edge as marked in the field and as directed by State. Haul material to designated waste area, spread and compact.

From Station	To Station	Distance Into Cutbank(ft)
77+10	78+20	2

EXHIBIT D
FOREST ROAD SPECIFICATIONS
ADDITIONAL ROAD INSTRUCTIONS

C to D: Clean ditchouts at stations 6+00, 8+00, 11+20, 13+30, 16+30, and 22+10.

Remove ravel from road edge as marked in the field and as directed by State. Haul material to designated waste area, spread and compact.

Station	Amount(cy)
79+10	10

E to F: Widen road into cutbank as directed by State. Place in road and compact, or endhaul to Point F and compact.

From Station	To Station	Distance Into Cutbank(ft)
0+00	6+00	2

Excavate and endhaul material between A to B and E to F(0+00 to 0+55) and slope between the two roads to create curve for log truck traffic.

Construct minimum 60ft landing at Point F.

G to H: Construct minimum 60ft landing at Point H.

I to J: Construct minimum 60ft landing at station 8+30 and at Point J.

Add the following amounts of curve widening to the 16ft subgrade for the sections of road shown.

From Station	To Station	Width(ft)
8+10	8+60	6

Max Grade(0+00 to 7+60) 20%
Max Grade(7+60 to 10+60) 15%

K to L: Construct minimum 70ft landing at Point L.

Construct approach to go both directions on I to J.

M to N: Construct minimum 60ft landing at Point N.

O to P: Remove ravel from road edge as marked in the field and as directed by State. Haul material to designated waste area, spread and compact.

Station	Amount(cy)
1+70	10

Q to R: Clear minimum 70ft landing at Point R.

Max Grade 18%.

Pullback the existing sidecast between the following stations on the existing dozer trail, according to specifications in Exhibit K and as marked in the field. Haul material to designated waste area, spread and compact.

From Station	To Station	Depth(ft)	Width(ft)
2+25	2+55	2	3

S to T: Expend 16 hours work with a Cat 325 or equivalent excavator and 12 hours with a 25cubic yard off-highway dump truck between point S and Point T, shown on Exhibit A, plucking alders, removing ravel and cut bank sluff, constructing waterbars, sidecast pullback, waste area cleanup, and road closure as directed by STATE.

Grading, shaping, and compaction for this segment is not required.

EXHIBIT D
 FOREST ROAD SPECIFICATIONS
ADDITIONAL ROAD INSTRUCTIONS

U to V: Pullback the existing sidecast between the following stations, according to specifications in Exhibit K and as marked in the field. Haul material to designated waste area, spread and compact.

From Station	To Station	Depth(ft)	Width(ft)
18+15	18+55	2	4
18+55	19+40	10	15

Widen road into hillside, with a 3ft ditch, as marked in the field and as directed by State. Haul material to designated waste area, spread and compact.

From Station	To Station	Distance Into Cutbank(ft)
17+70	20+25	4
20+25	21+35	2

Excavate material and construct rip rap toe on the outside of the road, as directed by State and as marked in the field. Endhaul material to designated waste area, spread and compact.

From Station	To Station	Depth(ft)	Width(ft)
0+00	0+70	4	6

Point Y: Remove stump or log from road, backfill with 4"-0" jawrun.

EXHIBIT D

ROAD BRUSHING SPECIFICATIONS

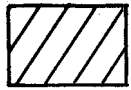

Clearing Limits

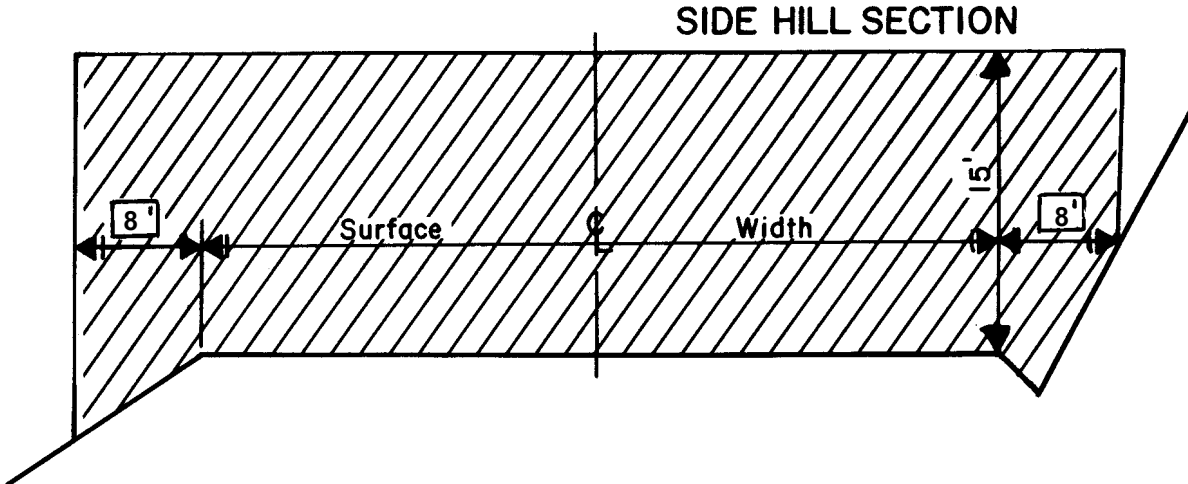

REQUIREMENTS

Unless otherwise approved in writing by STATE, brush and trees less than 8 inches DBH shall be cut to a height of 6 inches or less above the ground surface or obstructions such as rocks or existing stumps. Trees 8 inches or larger in diameter at stump height shall not be felled but shall be limbed for road visibility. Brushing on project road segments shall be completed prior to subgrade approval. Trees shall not be felled unless a portion of the bole is within the clearing limits.

When spur roads to be brushed end with a Landing, the Landing is to be brushed as directed by STATE.

At stream crossings brushing shall extend 14ft from the edge of the roadway on both sides in the draw.

Debris resulting from the brushing operation shall be removed from the roadway, cutslope, ditches, water courses, culvert inlet and outlets, and sediment catch basins within 72 hours and may be scattered downslope from the road or placed in other stable locations, unless otherwise approved by STATE.

Trees outside the clearing limits shall not be felled unless approved in writing by STATE.

CULVERT AND ROAD MARKER DAMAGES. Culvert and road markers damaged, or any portion of a marker damaged from PURCHASER activities shall be repaired or replaced by PURCHASER.

EXHIBIT D

FULL BENCH AND END-HAUL REQUIREMENTS

POINT TO POINT	STA. TO STA.	WASTE AREA LOCATION	WASTE AREA TREATMENT
A to B	17+70 to 30+45	Point A(SW of intersection)	Grass seed
A to B	118+30 to 119+30	WA #10	Grass seed
A to B	151+30 to 216+35	WA #2, #4, #5, or #6	Grass seed
C to D	77+10 to 111+15	WA #4, #11 or #12	Grass seed
E to F	Approach Widening	Point F	Grass seed
E to F	0+00	In road	None
E to F woody debris	All	A to B(166+85), Point F	None
G to H	All	WA #4 or #5	Grass seed
I to J	0+00 to 1+75	WA #2	Grass seed
I to J	3+60 to 5+00	WA #2 or #3	Grass seed
I to J	5+40 to 7+30	WA #3	Grass seed
I to J woody debris	Slopes >55%	Point I	None
O to P	Ravel Removal	WA #6	Grass seed
Q to R	All	WA #6	Grass seed
S to T	All	WA #1, #2, or #7	Grass seed
U to V	0+00 to 21+35	WA #8	Grass seed
Point Y	All	WA #13	Grass seed

Full Bench and End-Haul Areas General Requirements

Sidecast includes any road generated excess excavation material which is not essential as part of the road prism, is not compacted, and is below the roadway. Material shall not be sidecast unless specified above.

Clearing and grubbing debris shall be end-hauled.

When controlled blasting is required, it shall be accomplished using timing devices, delayed charges, low intensity shots, or other suitable means to contain material within the road prism.

Containment/Sidecast

Full Containment: Sidecast material lost over the outside edge of the road shall not exceed 6 inches in depth, measured perpendicular to the natural ground slope. Pioneer excavation shall be removed by digging, loading, and hauling rather than by pushing or scraping methods.

Tree bases and stumps may have up to 12 inches of material directly above them.

EXHIBIT D

FULL BENCH AND END-HAUL REQUIREMENTS

Any amount of material exceeding the containment requirements shall be removed by whatever means necessary and end-hauled to a designated waste area.

Waste Area Location

- (1) As shown on Exhibit A and as marked in the field.
- (2) Setback from slope break shall be a minimum of 20 feet horizontal measurement.
- (3) WA #1 has a maximum of 1,000yds that can be placed there. Material shall not exceed 10ft at deepest spot and shall not extend past marked trees.
- (3) WA #2 has a maximum of 1,000yds that can be placed there. Material shall not exceed 10ft at deepest spot and shall not extend past marked trees.
- (4) Only woody debris is allowed in woody debris waste areas.

Waste Area Treatment

- (1) Deposit at waste area, spread evenly, compact, and provide adequate drainage.
- (2) Pile woody debris separate from other waste material.
- (3) Seed all waste areas in accordance with Exhibit O.

EXHIBIT E

ROAD SURFACING

ROAD SEGMENT:		A to B		STATIONS:				0+00 to 222+85		
Application	Rock Size and Type	Location	Compacted Depth	Volume (CY) per		Number of Units	Curve Widening (CY)	Approx. Total (CY)		
Road Rock	Crushed 1.5"-0"	0+00 to 30+45	2 "	station	10	30.45	20	320		
Road Rock	Jawrun 4"-0"	181+85 to 222+85	6 "	station	30	41.00	60	1,290		
Turnouts	Crushed 1.5"-0"	A to B	2 "	TO	10	5	50			
Turnouts	Jawrun 4"-0"	A to B	6 "	TO	20	6	120			
Application	Rock Size and Type	Location	Approx. Total (CY)							
Spot Rock	Crushed 2"-0"	As Directed	300							
Culvert Backfill	Crushed 2"-0"	182+00	25							
Energy Dissipator	Rip Rap 12"-6"	182+00	5							
Landing Rock	Jawrun 4"-0"	222+85	60							
Energy Dissipator	Rip Rap 12"-6"	69+60	5							

ROAD SEGMENT:		C to D		STATIONS:				0+00 to 111+15		
Application	Rock Size and Type	Location	Compacted Depth	Volume (CY) per		Number of Units	Curve Widening (CY)	Approx. Total (CY)		
Road Rock	Jawrun 4"-0"	0+00 to 16+15	6 "	station	30	16.15	30	510		
Turnouts	Jawrun 4"-0"	C to D	6 "	TO	20	3	60			
Turnarounds	Jawrun 4"-0"	16+15	6 "	TA	20	1	20			
Application	Rock Size and Type	Location	Approx. Total (CY)							
Spot Rock	Crushed 2"-0"	As Directed	300							
Culvert Backfill	Crushed 2"-0"	0+40, 24+00	40							
Energy Dissipator	Rip Rap 12"-6"	0+40, 24+00	10							
Erosion Control	Jawrun 4"-0"	97+25	10							
Erosion Control	Jawrun 4"-0"	107+35	10							

ROAD SEGMENT:		E to F		STATIONS:				0+00 to 6+00		
Application	Rock Size and Type	Location	Compacted Depth	Volume (CY) per		Number of Units	Curve Widening (CY)	Approx. Total (CY)		
Road Rock	Jawrun 4"-0"	0+00 to 1+00	6 "	station	30	1.00	10	40		
Application	Rock Size and Type	Location	Approx. Total (CY)							
Intersection Rock	Jawrun 4"-0"	0+00	100							

EXHIBIT E

ROAD SURFACING

ROAD SEGMENT:		G to H		STATIONS:			0+00 to 5+15		
Application	Rock Size and Type	Location	Compacted Depth	Volume (CY) per		Number of Units	Curve Widening (CY)	Approx. Total (CY)	
Road Rock	Jawrun 4"-0"	0+00 to 5+15	9 "	station	50	5.15	20	280	
Application	Rock Size and Type	Location	Approx. Total (CY)						
Junction Rock	Jawrun 4"-0"	0+00	30						
Landing Rock	Jawrun 4"-0"	5+15	60						

ROAD SEGMENT:		I to J		STATIONS:			0+00 to 10+60		
Application	Rock Size and Type	Location	Compacted Depth	Volume (CY) per		Number of Units	Curve Widening (CY)	Approx. Total (CY)	
Road Rock	Jawrun 4"-0"	0+00 to 10+60	9 "	station	50	10.60	30	560	
Turnouts	Jawrun 4"-0"	I to J	9 "	TO	20	2		40	
Application	Rock Size and Type	Location	Approx. Total (CY)						
Junction Rock	Jawrun 4"-0"	0+00	30						
Landing Rock	Jawrun 4"-0"	8+30	50						
Landing Rock	Jawrun 4"-0"	10+60	70						
Energy Dissipator	Rip Rap 12"-6"	5+70	5						
Curve Widening	Jawrun 4"-0"	8+30	30						
Traction Rock	Crushed 2"-0"	As Needed	25						

ROAD SEGMENT:		K to L		STATIONS:			0+00 to 1+30		
Application	Rock Size and Type	Location	Compacted Depth	Volume (CY) per		Number of Units	Curve Widening (CY)	Approx. Total (CY)	
Road Rock	Jawrun 4"-0"	0+00 to 1+30	9 "	station	54	1.30	10	80	
Application	Rock Size and Type	Location	Approx. Total (CY)						
Junction Rock	Jawrun 4"-0"	0+00	50						
Landing Rock	Jawrun 4"-0"	1+30	80						

EXHIBIT E
ROAD SURFACING

ROAD SEGMENT: M to N		STATIONS:				0+00 to 1+45		
Application	Rock Size and Type	Location	Compacted Depth	Volume (CY) per	Number of Units	Curve Widening (CY)	Approx. Total (CY)	
Road Rock	Jawrun 4"-0"	0+00 to 1+45	9 "	station	48	1.45	10	80
Application	Rock Size and Type	Location	Approx. Total (CY)					
Junction Rock	Jawrun 4"-0"	0+00	50					
Landing Rock	Jawrun 4"-0"	1+45	70					

ROAD SEGMENT: O to P		STATIONS:				0+00 to 8+65		
Application	Rock Size and Type	Location	Compacted Depth	Volume (CY) per	Number of Units	Curve Widening (CY)	Approx. Total (CY)	
Road Rock	Jawrun 4"-0"	0+00 to 8+65	6 "	station	30	8.65	20	280
Application	Rock Size and Type	Location	Approx. Total (CY)					
Landing Rock	Jawrun 4"-0"	6+05	50					
Landing Rock	Jawrun 4"-0"	8+65	50					

ROAD SEGMENT: Q to R		STATIONS:				0+00 to 4+70		
Application	Rock Size and Type	Location	Compacted Depth	Volume (CY) per	Number of Units	Curve Widening (CY)	Approx. Total (CY)	
Road Rock	Jawrun 4"-0"	0+00 to 4+70	9 "	station	51	4.70	20	260
Turnarounds	Jawrun 4"-0"	0+00	9 "	TA	30	1	30	
Application	Rock Size and Type	Location	Approx. Total (CY)					
Junction Rock	Jawrun 4"-0"	0+00	30					
Landing Rock	Jawrun 4"-0"	4+70	80					

ROAD SEGMENT: U to V		STATIONS:				0+00 to 21+35		
Application	Rock Size and Type	Location	Approx. Total (CY)					
Rip Rap Toe	Pitrun 6"-0"	0+35	20					
Rip Rap Toe	Riprap 36"-12"	0+35	30					
Fill Repair	Crushed 2"-0"	0+35	10					
Widening	Pitrun 6"-0"	19+40	50					
Widening	Crushed 2"-0"	19+40	20					

EXHIBIT E

ROAD SURFACING

ROAD SEGMENT:	Point Y	STATIONS:	0+00
Application	Rock Size and Type	Location	Approx. Total (CY)
Fill Armor	Rip Rap 24"-12"	0+00	5
Fill Repair	Jawrun 4"-0"	0+00	20

TOTAL ROCK	36"-12" Riprap	24"-12" Riprap	12"-6" Riprap	6"-0" Pitrun	4"-0" Jawrun	2"-0" Crushed	1 1/2"-0 Crushed
5,800CY	30CY	5CY	25CY	70CY	4,580CY	720CY	370CY

Roads shall be uniformly graded and approved by STATE prior to rocking. Additional rock for curve widening is required and has been included in the volume estimates. Turnouts, turnarounds, landings and junctions shall be rocked concurrently with the road. End-dumping of riprap shall not be allowed, unless otherwise approved in writing by STATE. Any additional turnarounds or turnouts created during any operation associated with this timber sale shall be rocked at PURCHASER's expense and as instructed by STATE.

For typical cross section, turnout and turnaround see Forestry Department Drawing Nos. 351-C, 351-D and TOTA-1 at the Forestry Department district office.

CRUSHED ROCK SPECIFICATIONS

Materials. The material shall be fragments of rock crushed to the required size. The material shall be free from vegetation and lumps of clay. STATE may require screening and/or rejecting of materials utilized for production of crushed rock for the purpose of removing excess fine material. Excess fines are present, when greater than 5 percent of a total rock sample weight, passes a #200 sieve. Rock crushing shall be limited to periods when weather conditions are acceptable to STATE.

Quality and Grading Requirements. The base material shall be rock. River gravel shall not be used. Crushed rock shall meet the grading requirements that follow;

Hardness - Test Method AASHTO T 96: 30% Maximum

Durability - Test Method ODOT TM 208
Passing No. 20 Sieve: 30% Maximum

For the purpose of crushing rock specified under the projects in Section 2610, "Project Work," PURCHASER shall utilize a jaw with screen rock crusher, or equivalent, unless otherwise approved by STATE. All rock from the Kilchis Pit shall be prescreened before crushing, with material smaller the 3/4" being reject material and hauled to designated WA #9.

The rock crusher shall be calibrated to produce rock as specified in this exhibit. Prior to the commencement of production crushing, PURCHASER shall sample, test, and provide rock test results meeting STATE specifications. STATE may then sample and test crushed rock for approval to proceed. PURCHASER shall take one sample of each 2,000 cubic yards of crushed rock material produced thereafter, using approved AASHTO sampling procedures. PURCHASER shall submit samples to a certified laboratory or shall perform testing for gradation requirements using AASHTO T 11 and AASHTO T 27 testing procedures. Prior to testing, each sample shall be split, making one-half of the sample, with proper identification, available for testing by STATE. Each sample and the results of PURCHASER testing shall be made available to STATE within 24 hours of sampling. Any rock crushed prior to STATE approval to proceed shall not be credited to the required rock quantity. Any subsequent rock tests not meeting STATE specifications shall be reason for rejection of that portion of crushed rock produced after that test and shall not be credited to the required rock quantity. STATE may sample the crushed rock at any time during the operation. Results of STATE's tests shall prevail over all other test results.

EXHIBIT E

CRUSHED ROCK SPECIFICATIONS

<u>For 1 1/2"-0" Crushed</u>	Passing	2" sieve	100%
	Passing	1.5" sieve	95-100%
	Passing	3/4" sieve	55-90%
	Passing	1/4" sieve	35-50%
	Passing	#10 sieve	15-35%
	Passing	#40 sieve	5-20%
<u>For 4"-0" Jawrun</u>	Passing	4" sieve	95%
	Passing	2" sieve	40-60%
	Passing	1/4 " sieve	10% maximum
<u>For 6"-0" Pitrun</u>	Passing	10" sieve	100%
	Passing	6" sieve	60-85%
	Passing	3" sieve	30-50%
	Passing	1/4 " sieve	10% maximum
<u>For 12"-6" Riprap</u>	50 percent or more of the material shall measure at least 12 inches in one dimension. Material shall be clean, well graded, and free of 2"-0" fines.		
<u>For 24"-12" Riprap</u>	50% or more of the rock shall be at 24 inches in one dimension. 100% of the rock shall be at least 12 inches in one dimension.		
<u>For 36"-12" Riprap</u>	50% or more of the rock shall be at 36 inches in one dimension. 100% of the rock shall be at least 12 inches in one dimension.		

Control of riprap and pitrun gradation shall be by visual inspection by STATE. Pitrun shall be reasonably free of organic material and shall not contain an excessive amount of oversized (cobble or boulders) or undersized (clay, silt or sand) particles.

The referenced sieve shall have square openings as set forth in AASHTO M 92, Woven Cloth Series. The determinations of size and gradings shall be as set forth in AASHTO T 27.

ROCK ACCOUNTABILITY

PURCHASER shall obtain subgrade approval from STATE prior to rocking. Rocking shall be limited to periods when weather conditions are acceptable to STATE and when sediment will not enter streams. Additional surfacing needed because of construction season or construction practice is not included in the preceding ROAD SURFACING table, and shall be furnished at PURCHASER expense.

Rock accountability shall be determined by depth measurement, except A to B(0+00 to 30+45, which will Load Records. STATE shall be given 24 hours' notice prior to rocking.

Depth Measurement. Rock shall be spread and compacted according to the depths specified in Exhibit E. Truck measure volumes are given, but shall not limit the amount of rock spread. Depth shall be determined in the most compacted area of the surface cross section. The depth of compacted aggregates shall not vary more than 1 inch from the depth specified in the "Road Surfacing" table in Exhibit E. The average depth for each road segment shall be the specified depth or greater. If additional rock is required because of insufficient depth, the locations and volumes to be added shall be determined by STATE. The conversion from compacted yardage to truck yardage is 1.3 multiplied by the compacted yardage equals truck yardage.

Landings, Junctions, Turnouts, Turnarounds, and Heliports shall have a minimum rock volumes as shown in Exhibit E and visual inspections by STATE.

Curve Surfacing. Extra surface width shall be required for the inside of all curves as follows: 400 divided by the radius of the curve equals the amount of extra width to be surfaced at the depths shown in Exhibit E.

Load Records. Notify STATE before spreading the rock and maintain a record of all rock delivered for spreading. Make the record available for STATE inspection. For Commercial Rock only.

EXHIBIT E

COMPACTION AND PROCESSING REQUIREMENTS

Moisture Content: Compaction must take place when moisture content of the materials being compacted is favorable for effective compaction as determined by STATE.

Compaction Pass: A pass is defined as traveling a road section forward and then backward over that same section.

Subgrade. Subgrade surfaces of the road segments listed below shall be graded and compacted prior to rocking. Compaction shall be accomplished by traveling all surfaces from shoulder to shoulder until the surface is smooth and hard and visible deformation ceases. At least 3 passes shall be made over the entire width and length of the road. Compaction shall be accomplished by using one or more of the approved equipment options listed below:

Subgrade shall be crowned or outsloped at 4 to 6 percent as specified in the “Forest Roads Specifications” table in Exhibit D.

ROAD SEGMENT	COMPACTION EQUIPMENT OPTIONS
G to H, I to J, K to L, M to N, Q to R	Vibratory Roller

Fills. Embankments and fills shall be placed in approximately horizontal layers not more than 8 inches in depth. Each layer shall be separately, and thoroughly, compacted. Compaction equipment shall be operated over the entire width of each layer until visible deformation of the layers cease. At least 3 passes shall be made over the entire width and length of each layer.

Placing individual rocks or boulders with more depth than the allowed layer thickness shall be permitted, provided the embankment will accommodate them. Such rocks and boulders shall be at least 6 inches below the subgrade. They shall be carefully distributed and the voids filled with finer material, forming a dense and compacted mass. Compaction shall be accomplished by using one or more of the approved equipment options listed below:

ROAD SEGMENT	COMPACTION EQUIPMENT OPTIONS
A to B & C to D culverts, Point Y	Hand operated tamper

Crushed Rock. The rock shall be uniformly mixed and spread in layers on the approved roadbed. Each layer of crushed rock shall be moistened or dried to uniform moisture content suitable for maximum compaction and compacted in layers not to exceed 6 inches in depth. When more than 1 layer is required, each shall be shaped, compacted, and approved by STATE before the succeeding layer is placed. Any irregularities or depressions that develop during compaction of the top layer shall be corrected by loosening the material at these places and adding or removing material until the surface is smooth and uniform. Each layer shall be compacted with a minimum of 3 passes over the entire width and length of the road until the surface is smooth and hard and visible deformation ceases. Compaction shall be accomplished by using one or more of the approved equipment options listed below:

Rock shall be compacted and processed during the same project period it is spread, unless otherwise approved in writing by STATE.

Rock shall be crowned or outsloped at 4 to 6 percent as specified in the “Forest Roads Specifications” table in Exhibit D.

ROAD SEGMENT	COMPACTION EQUIPMENT OPTIONS
All	Vibratory Roller

EXHIBIT E

COMPACTION AND PROCESSING REQUIREMENTS

Existing Crushed Rock. The existing rock shall be unearthed to a minimum depth of 4 inches or to 1 inch below the bottom of potholes, whichever is greater. The existing rock shall then be uniformly mixed and moistened or dried to a uniform moisture content suitable for maximum compaction and compacted. Any irregularities or depressions that develop during compaction shall be corrected by loosening the material at these places and adding or removing material until the surface is smooth and uniform. The existing rock shall be compacted with a minimum of 3 passes over the entire width and length of the road. Compaction shall be accomplished by using the approved equipment listed below or others approved by STATE:

Existing crushed rock shall be compacted and processed after completion of all project work and log hauling, unless otherwise approved in writing by STATE.

Rock shall be crowned or outsloped at 4 to 6 percent as specified in the "Forest Roads Specifications" table in Exhibit D.

ROAD SEGMENT	COMPACTION EQUIPMENT OPTIONS
A to B, C to D, O to P	Vibratory Roller

Pit-Run Rock. Pit-run surfacing rock shall be spread on roads with a crawler tractor and continuously walked-in. Rock spreading shall begin at nearest point from the rock source and progress toward the end of the project, unless otherwise approved in writing by STATE. Compaction shall be accomplished by using the approved equipment listed below or others approved by STATE:

Rock shall be compacted and processed during the same project period it is spread, unless otherwise approved in writing by STATE.

Rock shall be crowned or outsloped at 4 to 6 percent as specified in the "Forest Roads Specifications" table in Exhibit D.

ROAD SEGMENT	COMPACTION EQUIPMENT OPTIONS
U to V	Crawler Tractor

COMPACTION EQUIPMENT OPTIONS

Vibratory Rollers. The drum shall have a smooth surface, a diameter not less than 48 inches, a width not less than 58 inches, and a turning radius of 15 feet or less. Vibration frequency shall be regulated in steps to 1400, 1500, and 1600 VPM, corresponding to engine speeds of 1575, 1690, and 1800 RPM. The centrifugal force developed shall be 7 tons at 1600 VPM. It shall be activated by a power unit of not less than 25 horsepower. The vibratory roller shall be self-propelled and operated at speeds ranging from 0.9 miles to 1.8 miles per hour, as directed by STATE.

Vibratory Hand-Operated or Backhoe-Mounted Tamper. Vibratory hand-held or hydraulic tampers shall be used for compaction of backfill materials around culverts (and/or bridge approach embankment materials around abutments). The tamper shoe dimensions shall be a minimum of 10" X 13" and capable of a centrifugal force of 2,250 pounds.

Crawler Tractors. A dozer/track-type tractor weighing a minimum of 45,000 pounds as directed by STATE shall be operated over the pit-run or jaw-run rock so that the entire surface comes in contact with the tracks.

EXHIBIT F

ROCK QUARRY DEVELOPMENT AND USE

1. PURCHASER shall prepare a written development plan for the quarry area. The plan shall be submitted to STATE for approval prior to conducting any operation in quarry area. The plan shall include, but not be limited to:
 - (a) Location of quarry floor, benches, and roads to benches.
 - (b) Disposal site for woody debris, overburden and reject material.
 - (c) Time lines for rock quarry use.
 - (d) Erosion control measures.
 - (e) Oversize material location
2. PURCHASER shall schedule and coordinate quarry and stockpile usage with other existing or planned activity requiring quarry or stockpile usage. **PURCHASER shall notify STATE 5 days prior to the start of quarry development activities.**
3. Fall all timber within the posted right-of-way boundary and remove all merchantable timber. All woody debris, including stumps and slash shall be hauled to the designated disposal areas.
4. Where overburden removal limits have not been marked, they shall extend for a distance of at least 20 feet beyond the developed rock source. Overburden removal limits, when marked, are designated by orange right-of-way boundary tags. Overburden shall be hauled to a designated waste area. Overburden shall be spread evenly, grass seeded, and compacted at the waste area and woody debris stacked separately. Areas of overburden removal shall be inspected for completeness and approved by STATE prior to drilling or rock removal.
5. PURCHASER shall conduct the Operations relative to the disposal of waste material in such manner that silt, rock, debris, dirt, or clay shall not be washed, conveyed, or otherwise deposited in any stream. All waste shall be deposited at an approved "waste disposal site."
6. The quarry floor shall be developed to provide drainage away from the quarry. Drainage ditches shall not discharge into streams.
7. Benches shall be constructed and maintained at intervals of 40 feet or less in height and shall be a minimum of 20 feet in width. Any gravel or talus slopes shall be left with a working face at an angle of 60 percent or less. There shall be a minimum of one bench with an access road to it. Said bench shall be easily accessible with tractors.
8. The STATE shall be notified two working days prior to the beginning of drilling operations. Working days shall be defined as Monday through Friday, 6:00 a.m. to 2:30 p.m.
9. Controlled blasting techniques shall be utilized for any blasting operations, and shall be accomplished using timing devices, delayed charges, low intensity shots, or other suitable means to contain as much material as possible within the quarry development area (full containment). Each low intensity shot shall be shot into the previous shots' void in order to contain all the material in the quarry development area. Each shot shall also have a "tattle-tale" end cap so that it is known if all charges were detonated. The purchaser shall detonate or remove all non-detonated explosives from STATE LANDS. PURCHASER shall maintain a comprehensive blasting log that contains all pertinent data for all blasting operations. The blasting log shall be submitted to the STATE after the completion of all blasting activity. The blasting log is intended for STATE record keeping purposes only.

EXHIBIT F

ROCK QUARRY DEVELOPMENT AND USE

10. Quarry face shall be developed in a uniform manner. All quarry backslopes shall be left in a stable condition.
11. Oversized material that is produced shall be piled in the vicinity of the quarry as directed by STATE.
12. The quarry site shall be left in a condition free from overburden and debris. Access roads to the quarry, benches, and the quarry floor shall be cleared of unused shot rock and dirt at the termination of use. Access roads shall be waterbarred to provide drainage as specified in Exhibit I and blocked as directed by STATE. Unused shot rock material that is produced shall be piled in the vicinity of the quarry as directed by STATE. Dirt, overburden, and reject material shall be hauled to designated waste area.
13. Proper winterization and storm-water control measures such as waterbarring, drainage, utilization of filter bales, mulching and/or blocking access shall be constructed and maintained to protect the watershed and Project Work, as directed by STATE.
14. Apply seed to the waste area, as specified in Exhibit O.
15. Kilchis Pit- Endhaul all waste material to WA#9.
16. A drilling and shooting prework is required before any drilling begins for each rock pit. A shooting plan must be submitted to State for review before operations begin.
17. Kilchis Pit floor may be taken down to meet volume requirements. Grades for Cedar Butte Road and Kilchis Forest Road shall conform to those listed in Exhibit D.
18. Only woody debris may be placed in the "Woody Debris Waste Areas".

EXHIBIT G

CULVERT SPECIFICATIONS

All culvert materials shall be furnished and installed by PURCHASER, unless otherwise specified in the Contract. Culverts shall be constructed of corrugated polyethylene. Polyethylene culverts shall be double-walled and meet the requirements of AASHTO M-294-11, Type S, or ASTM F2648.

Lengths of individual culvert sections shall be not less than 10 feet, unless otherwise provided for in special instructions. The shortest culvert section length shall be placed at the inlet end.

Joining shall be done with bands of like material and corrugations. Manufacturers' instructions shall be followed for prefabricated pipe assembly. Polyethylene joints shall be made with split couplings, corrugated to engage the culvert corrugations, and shall engage a minimum of 4 corrugations, 2 on each side of the culvert joint.

Culverts shall be located according to the alignment and grade as shown on the Plan and Profile, and/or as staked in the field, or as specified in special instructions.

The STATE Representative shall determine final culvert locations and stake the locations in the field prior to installation.

Cross drain culverts on road grades in excess of 3 percent shall be skewed at least 30 degrees from perpendicular to the road centerline, except that cross drain culverts at the low point of dips in roads shall not be skewed.

Culvert grade shall slope away from ditch grade at least 5 percent unless otherwise specified.

The foundation and trench walls for all culverts shall be free from logs, stumps, limbs, stones, and other objects which would dent or damage the culvert. The culvert trench shall be excavated 3 culvert diameters wide to permit compaction and working on each side of the culvert. Tamping shall be done in 6-inch lifts, 1 culvert diameter each side of the culvert to 95 percent density or over. Bedrock shall be excavated as required to provide a uniform foundation for the full length of the culvert. Minimum bedding depth shall be 6 inches.

A bedding of granulated material or crushed rock as specified in Exhibit E shall be placed to provide a wide band of support and to transmit the load from above evenly over the entire length of the culvert.

Backfill shall consist of granulated material, crushed rock as specified in Exhibit E, or job-excavated soil free of stumps, limbs, rocks, or other objects which would damage the culvert.

Transporting of the culvert shall be done carefully. Dragging or allowing free fall from trucks or into trenches shall not be permitted.

Minimum height of cover over top of culvert to subgrade when road is to be rockered shall be 12".

The ends of each culvert shall be free of logs and debris which would restrict the free flow of water. The intake end of relief culverts shall be provided with a sediment catching basin 3 feet in diameter at the bottom. The outlet end of any culvert which would allow water to erode embankment soil shall be provided with an energy dissipator, half round, or other approved slope protection device. Construct lead-off ditches away from culvert outlets where the slope gradients restrict the free flow of water.

Tamping is required on all culverts.

The intake end of culverts shall be marked by installing a 5 foot long, rust-resistant painted steel fence post two feet into the ground, within 6 inches of the inlet on the downgrade side.

EXHIBIT G

CULVERT SPECIFICATIONS

Damaged culvert inlets and/or outlets shall be repaired by opening them with a hydraulic jack or cutting off the culvert end to allow for free passage of water at peak flow levels.

A manufacturer's certification that the product was manufactured, tested, and supplied in accordance with this specification shall be furnished to STATE upon request.

EXHIBIT G

CULVERT LIST

CULVERT NO.	DIAMETER (Inches)	LENGTH (Feet)	ROAD SEGMENT Point to Point	STATION
1	18	50	A to B	182+00
2	18	30	C to D	0+40
3	18	30	C to D	24+00
4	18	30	I to J	5+70

TOTAL LENGTHS BY DIAMETER
18 INCH
140 Feet

EXHIBIT H

TYPICAL EMBEDDED ENERGY DISSIPATOR

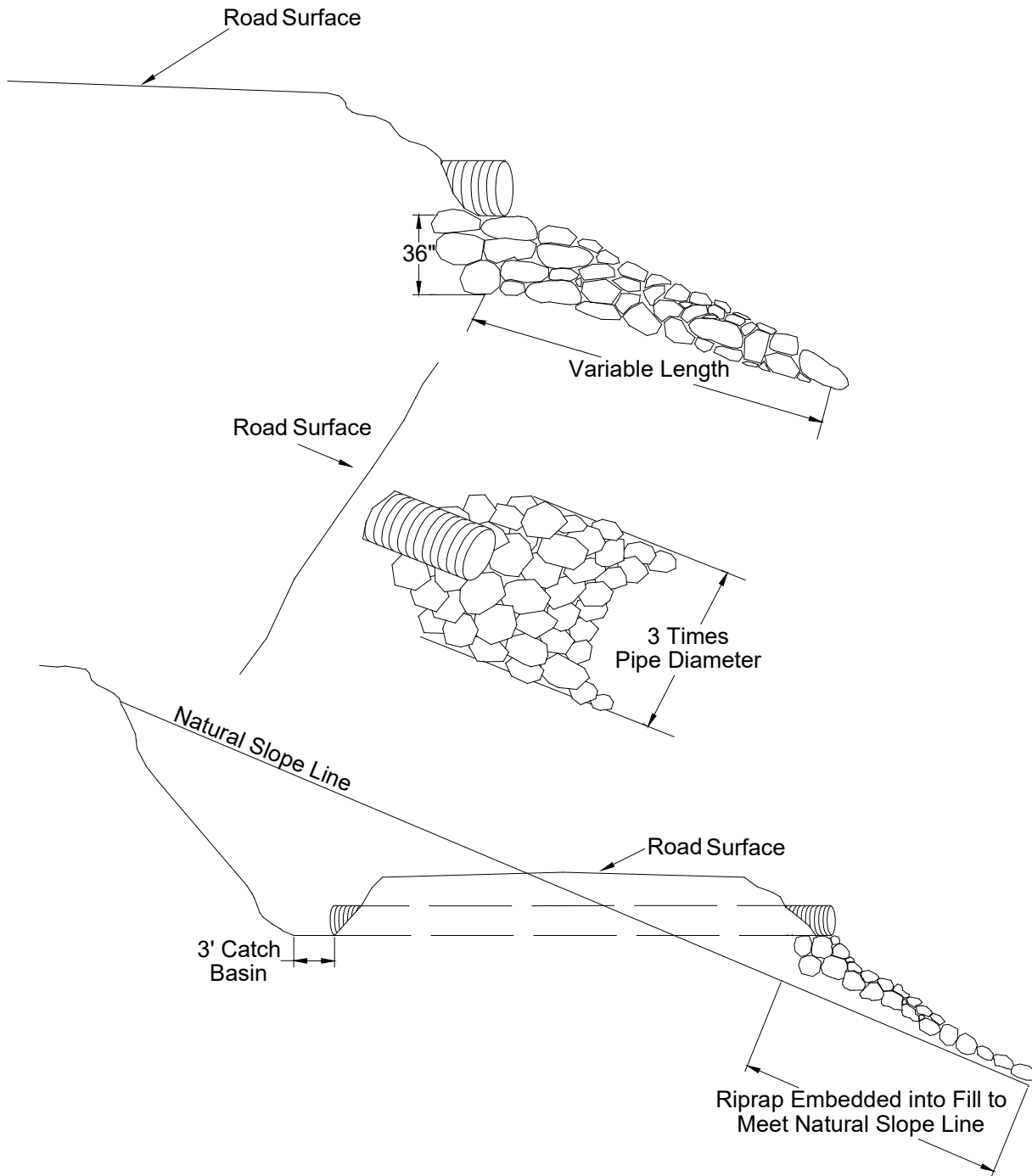
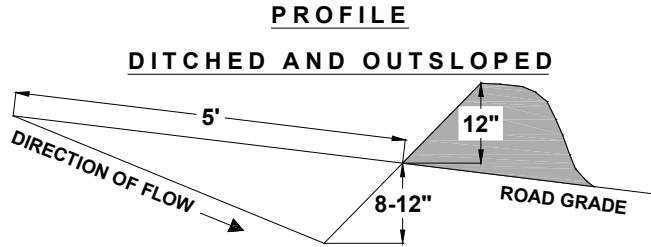
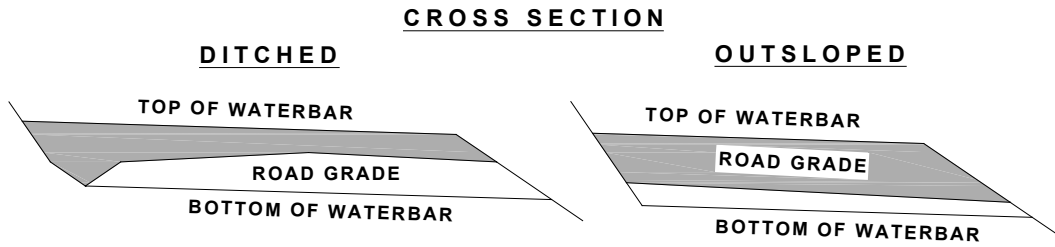

EXHIBIT I
WATERBAR SPECIFICATIONS



SPACING OF WATERBARS	
ROAD GRADE	DISTANCE
< 6 %	400'
6 - 10 %	200'
11 - 15 %	150'
> 15 %	100'



CONSTRUCT DITCHOUT THRU ANY EXISTING BERM.
CROSS DRAINAGE GRADIENT MINIMUM 3%.

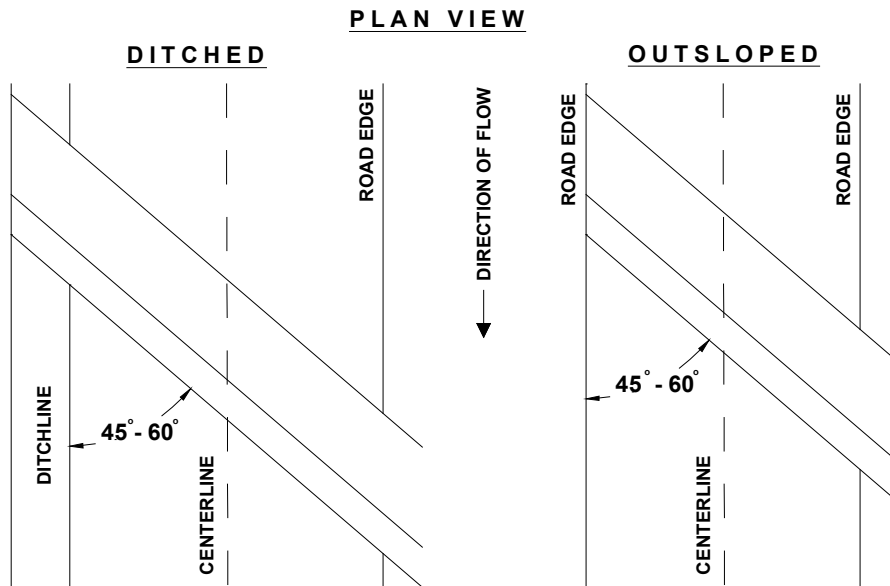
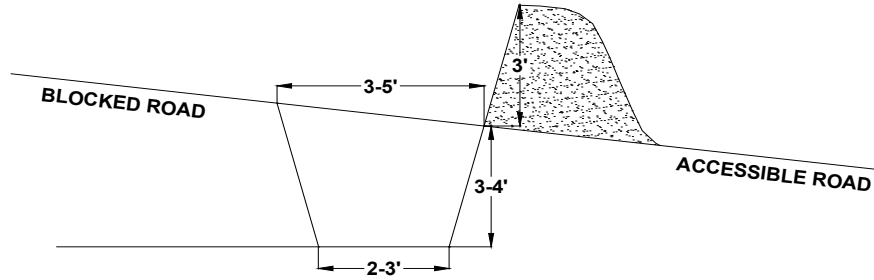

EXHIBIT J

TANK TRAP SPECIFICATIONS

**PROFILE
DITCHED AND OUTSLOPED**



CROSS SECTION

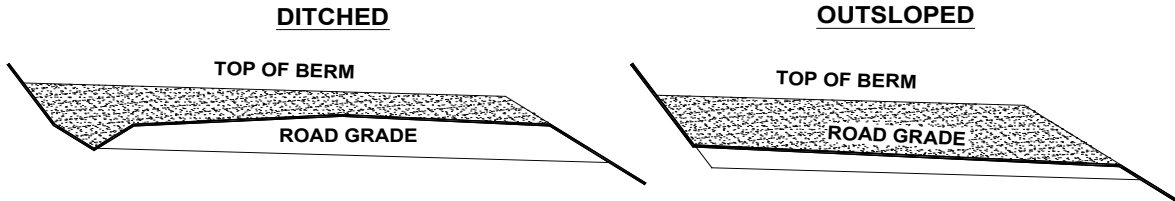

CONSTRUCT DITCHOUT THRU ANY EXISTING BERM.
CROSS DRAINAGE GRADIENT MINIMUM 3%

PLAN VIEW

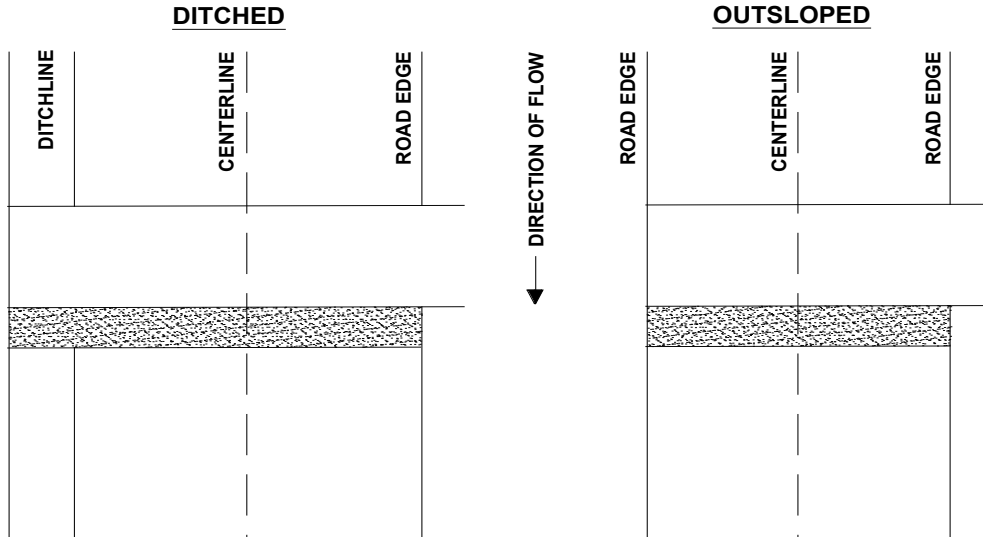

It should be sloped to drain with a relief ditch through the down slope edge of the road. The trench shall be behind the berm for approaching traffic.

EXHIBIT K

RUBBER WATER DIVERTER

GENERAL NOTES

1. CONVEYOR BELTING: 3 OR 5 PLY, 600 Lb. TENSILE STRENGTH PER INCH OF WIDTH, NYLON FABRIC, 3/8" x 1/8" COVERING, 26" x 16'.
2. TIMBER: (4" x 8") nom. x 16'
TIMBER SHALL BE PRESSURE TREATED (GROUND CONTACT TYPE).
4" SIDE OF TIMBER SHALL BE INSTALLED VERTICALLY AS ILLUSTRATED IN SECTION A-A.
3. GALVANIZED LAG SCREWS: 3/8" x 3" (8 EACH) WITH 3/8" GALVANIZED WASHERS (23" SPACING FOR SCREWS).
4. MARKER: 72" LONG CARSONITE MODEL CRM-375 WITH 3" x 4" REFLECTOR ON EACH SIDE OR APPROVED EQUIVALENT.
5. BACKFILL MATERIAL SHALL BE PLACED IN 4" COMPACTED LIFTS, DENSITY SHALL EXCEED THE DENSITY OF THE SURROUNDING ROAD SURFACE MATERIAL.

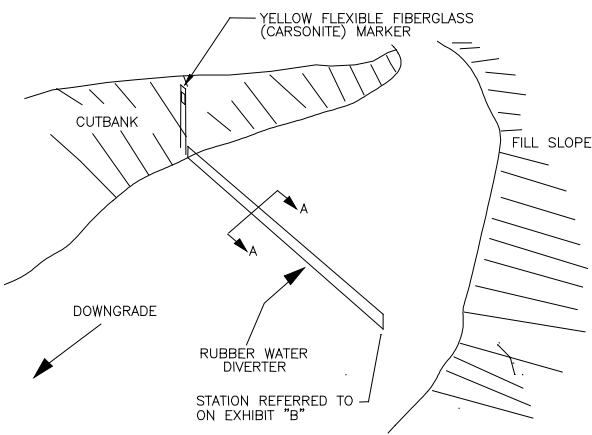

INSTALLATION DETAIL

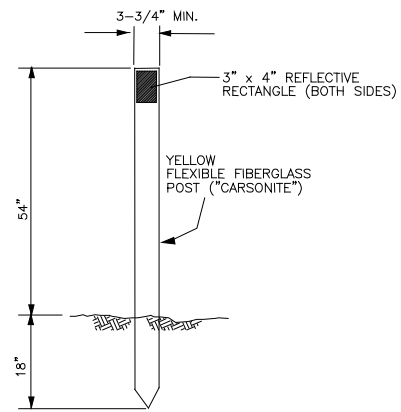

MARKER

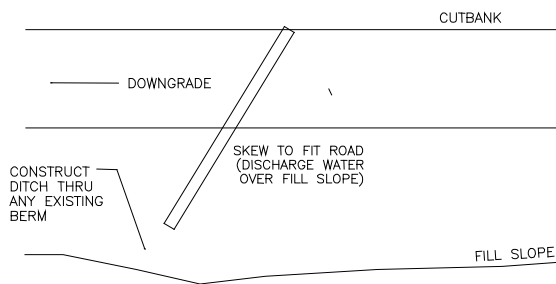

SKEW DIAGRAM (PLAN VIEW)

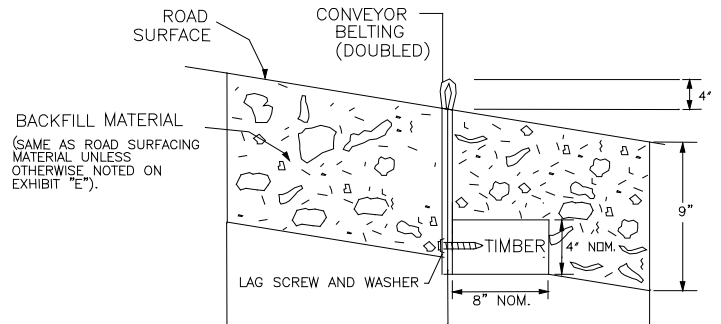

SECTION A-A

*DRAWINGS NOT TO SCALE

EXHIBIT L
TYPICAL SIDECAST PULLBACK

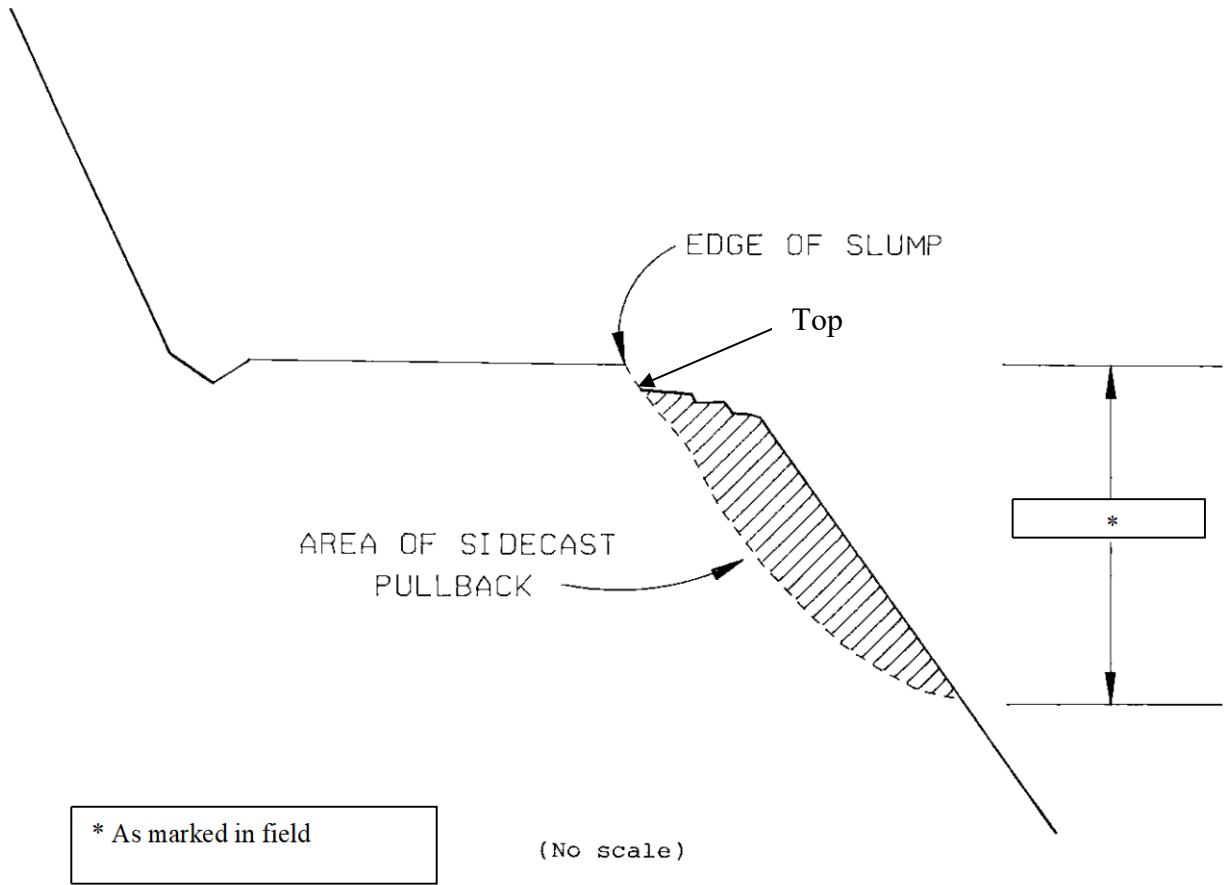
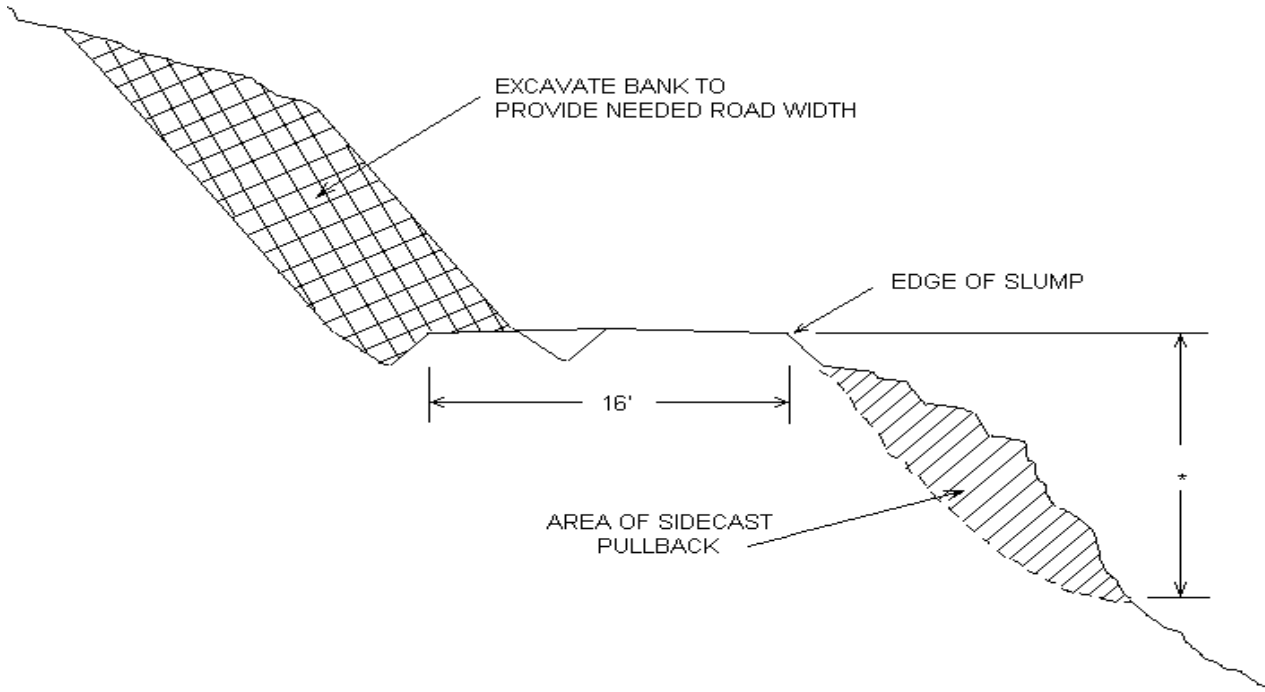

EXHIBIT L

TYPICAL CROSS SECTION VIEW OF SIDECAST PULLBACK AND ROAD REALIGNMENT



(No Scale)

* As marked in field

EXHIBIT M

SPECIFICATIONS FOR LANDING SLASH PILING

Piling Slash: All piles shall be as compact as possible. Piles shall be built to a height of 3 to 4 feet and then covered to prevent water from reaching the Slash. Each pile shall be covered with polyethylene plastic sheeting. State shall supply the materials used for covering the Slash. Additional woody debris shall be piled on top of the covered piles to complete the piling, as directed by STATE.

Placement of Piles: Piles shall be placed in a location to minimize damage from burning to standing green trees, snags, and culverts. Piles shall be placed as follows:

- (a) No less than 50 feet from any snag, green tree, or culvert, unless otherwise approved by STATE.
- (b) Cull log segments suitable for firewood shall be piled separately from Slash at a distance of no closer than 50 feet from the Slash piles.

EXHIBIT N

SPECIFICATIONS FOR SKID ROAD CLOSURE

All skid/forwarder roads shall be closed by PURCHASER prior to the timber sale completion.

Skid roads shall be closed by constructing a barrier which makes the road impassable to vehicular traffic. Where skid roads meet permanent forest roads, PURCHASER shall block access to vehicular traffic by placing several root wads across the road.

All berms or holes caused by logging Operations shall be flattened out to as close to the natural slope as possible.

Scatter locally available woody material (logs, stumps, brush, Slash, etc.) on the closed running surface.

Waterbar the subgrade and running surface at a spacing of no more than 100 feet and as specified in Exhibit I, "Waterbar Specifications."

Apply forage seed to the roadbed as specified in Exhibit O, "Seeding and Fertilizing."

EXHIBIT O

SEEDING

This work shall consist of preparing seedbeds and furnishing and placing required seed.

Seeding Seasons. Seeding shall be performed only from March 1 through June 15 and August 15 through October 15. Seeding materials shall not be applied during windy weather or when the ground is excessively wet or frozen. Areas of disturbed soil shall be seeded by the end of the project period in which work was started.

Soil Preparation. Areas to be seeded that have been damaged by erosion or other causes shall be restored prior to seeding. All areas to be seeded shall be finished and then cultivated to provide a reasonably firm, but friable seedbed. A minimum of 1/2 inch of surface soil shall be in a loose condition.

Application Methods for Seed

Dry Method. Mechanical seeders, seed drills, landscape seeders, cultipacker seeders, or other approved mechanical seeding equipment shall be used to apply the seed in the amounts and mixtures specified. Hand-operated seeding devices may be used when seed is applied in dry form.

Application Rates for Seed

Seed listed below shall be applied at the following rates per acre:

SPECIES	Lb./Acre	MIXTURE	PURE LIVE SEED	Repellent
Fine Fescue	24	40%	98%	0
Annual Ryegrass	12	20%	98%	0
Perennial Ryegrass	18	30%	98%	0
White Dutch Clover	6	10%	98%	0

Seeding will be considered acceptable when all other specified requirements in Exhibit O have been completed and a healthy, uniform, close stand of grass has been established, unless otherwise approved in writing by STATE.

MULCHING

This work shall consist of furnishing and placing required mulch. Mulch shall consist of straw that is free of noxious weeds.

Mulching Period. Straw mulch shall be applied within 24 hours of spreading grass seed.

Application Rates for Mulch

Place straw mulch to a reasonably uniform thickness of 3/4 to 1 ¼ inches. This rate requires between 1 and 1 ½ tons of dry mulch per acre.

WRITTEN PLAN FOR PROJECT WORK

PROTECTED RESOURCE: High Landslide Hazard Location.

LOCATION: Segment G to H, stations 2+10 to 4+60
NE ¼, NE ¼, Sec. 13, T1N, R8W, W.M., Tillamook County, Oregon.
NW ¼, NW ¼, Sec. 18, T1N, R7W, W.M., Tillamook County, Oregon.
Segment Q to R, stations 0+00 to 4+60
SW ¼, SE ¼, Sec. 7, T1N, R7W, W.M., Tillamook County, Oregon.

Activity: Road Construction across High Landslide Hazard Location.

Protection measures:

- Road construction will be performed only during dry weather conditions.
- Road subgrade will be no wider than necessary.
- Subgrade will be constructed using “full bench” techniques. No sidecast will occur.
- Excavation of road prism will be accomplished with an excavator.
- Excavated material will be hauled to a stable, designated waste area away from streams, spread and compacted.
- Berm will be left on outside edge of road during excavation to ensure 100% containment.
- Newly exposed soil will be seeded.
- Road will be outsloped for drainage.

Date: February 18, 2022

Prepared by: Scott Bushnell



"STEWARDSHIP IN FORESTRY"

PART IV OTHER INFORMATION

WRITTEN PLAN

SALE NAME: Lobo Canyon Sale# TL-341-2022-W00848-01

PROTECTED WATERS:

1. Arch Cape Mill Creek, Medium Type F Stream
2. Cedar Creek, Large Type F Stream
3. Lehman Creek, Medium Type F Stream

Definitions: Stream buffer – Type F: at least 100 feet horizontal distance from the high-water mark on each side of the stream.

LOCATION: Portions of Section 7, T1N, R7W, W.M., Tillamook County, Oregon.

Activity: Cable yarding across Medium and Large Type F stream.

Protection measures:

- All trees in the RMA are reserved from cutting.
- Cable yarding lines will be pulled out of the RMA prior to rigging the next yarding road.
- If trees or logs fall or slide into a stream channel they will not be limbed, bucked, or removed without prior approval from ODF.
- Cable lines will be an average of at least 100 feet apart where they extend over or through the Type F stream and buffer.

Date: February 16, 2022

Prepared by: Sara Stack, Forester