

# PART III: EXHIBITS

State Timber Sale Contract  
No. 341-11-79  
Jack Flash

EXHIBIT B

Page 1 of 3  
629-Form 341-203  
Revised 06/97

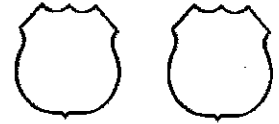
## OREGON DEPARTMENT OF FORESTRY

### TIMBER SALE OPERATIONS PLAN

(See Page 2 for instructions)

Date Received by STATE: \_\_\_\_\_

(5) State Brand Information (complete):



(1) Contract No.: 341-11-79

(2) Sale Name: Jack Flash

(3) Contract Expiration Date: June 30, 2014

Project Completion Dates: \_\_\_\_\_

(4) Purchaser: \_\_\_\_\_

(6) Purchaser Representatives:

Projects: \_\_\_\_\_

Phone: \_\_\_\_\_

Cell/Other

Phone: \_\_\_\_\_

Home: \_\_\_\_\_

Projects: \_\_\_\_\_

Phone: \_\_\_\_\_

Cell/Other

Phone: \_\_\_\_\_

Home: \_\_\_\_\_

Projects: \_\_\_\_\_

Phone: \_\_\_\_\_

Cell/Other

Phone: \_\_\_\_\_

Home: \_\_\_\_\_

Projects: \_\_\_\_\_

Phone: \_\_\_\_\_

Cell/Other

Phone: \_\_\_\_\_

Home: \_\_\_\_\_

Logging: \_\_\_\_\_

Phone: \_\_\_\_\_

Cell/Other

Phone: \_\_\_\_\_

Home: \_\_\_\_\_

Logging: \_\_\_\_\_

Phone: \_\_\_\_\_

Cell/Other

Phone: \_\_\_\_\_

Home: \_\_\_\_\_

Logging: \_\_\_\_\_

Phone: \_\_\_\_\_

Cell/Other

Phone: \_\_\_\_\_

Home: \_\_\_\_\_

Logging: \_\_\_\_\_

Phone: \_\_\_\_\_

Cell/Other

Phone: \_\_\_\_\_

Home: \_\_\_\_\_

(7) State Representatives:

Projects: \_\_\_\_\_

Phone: \_\_\_\_\_

Cell/Other

Phone: \_\_\_\_\_

Home: \_\_\_\_\_

Logging: \_\_\_\_\_

Phone: \_\_\_\_\_

Cell/Other

Phone: \_\_\_\_\_

Home: \_\_\_\_\_

(8) Name of Subcontractors & Starting Dates:

Projects: No(s) \_\_\_\_\_ - \_\_\_\_\_

Date: \_\_\_\_\_

Phone: \_\_\_\_\_

No(s) \_\_\_\_\_ - \_\_\_\_\_

Date: \_\_\_\_\_

Phone: \_\_\_\_\_

No(s) \_\_\_\_\_ - \_\_\_\_\_

Date: \_\_\_\_\_

Phone: \_\_\_\_\_

No(s) \_\_\_\_\_ - \_\_\_\_\_

Date: \_\_\_\_\_

Phone: \_\_\_\_\_

Logging: Felling \_\_\_\_\_

Date: \_\_\_\_\_

Phone: \_\_\_\_\_

Yarding: \_\_\_\_\_

Date: \_\_\_\_\_

Phone: \_\_\_\_\_

(9) Comments: \_\_\_\_\_  
\_\_\_\_\_  
\_\_\_\_\_  
\_\_\_\_\_  
\_\_\_\_\_

(10) Operations Map: Attach a copy of timber sale Exhibit A or other suitable map which plainly shows the items listed on the instruction sheet.

EXHIBIT B

INSTRUCTION SHEET FOR OPERATIONS PLAN

**SUBMIT ONE COPY OF PLAN TO STATE**

Operations shall be limited to the work shown in the plan until a revised plan or supplemental plan is submitted covering additional work. Compliance with this plan is not in lieu of compliance with any federal requirements related to the federal Endangered Species Act. If STATE has prepared a required Forest Practices Act (FPA) "Written Plan" for operations, PURCHASER shall comply with all provisions of the Written Plan.

**Explanation of Item No. (from Page 1)**

- (5) All sales require you to use a brand furnished by STATE. If the State brand has not been assigned when the plan is submitted, it will be furnished and assigned later. Complete drawing. If more than one brand is assigned to the sale, complete both drawings.
- (6) The contract requires you to have a designated representative available on the sale area or work location who is authorized to receive in your behalf any notice or instruction given by STATE and to take action in regard to performance under the contract. If logging and project work is widely separated, a representative is required for each.
- (7) The STATE representative will be designated when your plan is approved and is the person who will inspect and issue instructions regarding performance.
- (8) Show names of subcontractors to be used for any or all phases of the operations. If subcontractors are not known, or are changed later, give notification to the STATE representative prior to commencement of work by subcontractor.

Show projected dates for commencement of both projects and logging. If projected dates need to be changed at a later date, notification must be given to the STATE representative by supplemental plan or otherwise, prior to commencement of such operations.

- (10) The STATE representative will furnish extra copies of Exhibit A of the contract for your use in preparing the operations map. The map shall use the following legend and show:
  1. Landing locations, approximate setting boundaries, and probable sequence of logging the settings. Number the settings in sequence.
  2. Locations of spur roads planned for construction, other than those required by the timber sale contract. Provide spur road specifications.
  3. Location of proposed tractor yarding roads. Show if and how marked on the ground.
  4. Location of temporary stream crossings.
  5. List the sequence of performing project work.
  6. Location of rock sources - attach pit development plans.



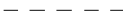



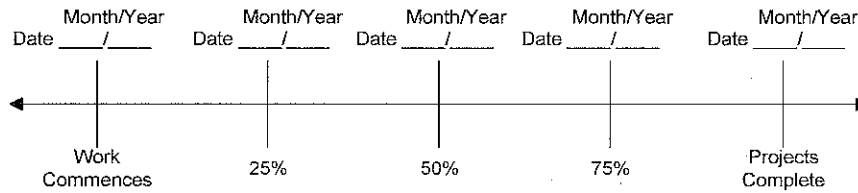
- |   |   |
|---|---|
|  | Cable Landing, with numbers for sequence.   |
|  | Tractor Landing with alphabetical sequence. |
|  | Approximate setting boundary.               |
|  | Spur truck roads.                           |
|  | Tractor yarding roads.                      |
|  | Temporary stream crossings.                 |

EXHIBIT B  
OPERATIONS PLAN

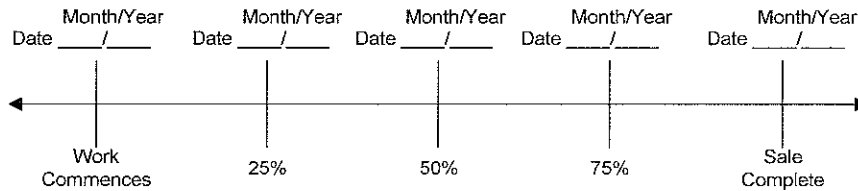
Completion Timeline

Indicate on the appropriate timeline below, the dates by which you plan to complete the work as required under this contract. The purpose of this section is to develop a plan that will ensure you complete the work as required, and meet the interim completion date(s) and contract expiration date. This plan is incorporated and made a part of the contract. When, in the opinion of STATE, operations are not commencing in a manner that meets the intent of this plan, you may be placed in violation of contract and your operations suspended until an amended plan is submitted and approved by STATE.

Projects



Harvest & Other Requirements



**The Federal Endangered Species Act (ESA) prohibits a person from taking any federally listed threatened or endangered species. Taking under the federal ESA may include alteration of habitat. STATE's approval of this plan does not certify that PURCHASER's operation under the plan is lawful under the federal ESA. As provided in the timber sale contract, PURCHASERS must comply with all applicable state, federal, and local laws.**

**PURCHASER's compliance with this plan is not in lieu of compliance with any federal requirements related to the federal Endangered Species Act.**

APPROVED: Date: \_\_\_\_\_

SUBMITTED BY:  
PURCHASER

STATE OF OREGON - DEPARTMENT OF FORESTRY

\_\_\_\_\_  
Title

\_\_\_\_\_  
Title

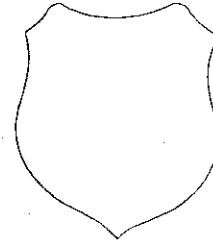
Original: Salem  
cc: District File  
Purchaser

EXHIBIT C – SAWMILL GRADE

SCALING INSTRUCTIONS -- LOCATION APPROVAL -- BRAND INFORMATION

- (1) ORIGINAL REGISTRATION  Date \_\_\_\_\_  
 REVISION NUMBER \_\_\_\_\_  Date \_\_\_\_\_  
 CANCELLATION  Date \_\_\_\_\_
- (2) TO: \_\_\_\_\_  
 (Third Party Scaling Organization)
- (3) FROM: Tillamook (06) Phone (503) 842-2545  
 (State Forestry District)  
 Address 5005 3<sup>rd</sup> Street, Tillamook, OR 97141
- (4) PURCHASER: \_\_\_\_\_  
 Mailing Address: \_\_\_\_\_  
 Phone Number: \_\_\_\_\_

- (13) SALE NAME: Jack Flash  
 COUNTY: Tillamook
- (14) STATE CONTRACT NUMBER: 341-11-79
- (15) STATE BRAND REGISTRATION NUMBER \_\_\_\_\_
- (16) STATE BRAND INFORMATION (COMPLETE):



- (17) PAINT REQUIRED: YES   
 COLOR: Orange

(5) MINIMUM SCALING SPECIFICATIONS			CLASS		
SPECIES	SCALING DIAMETER INCHES	*NET SCALE VOLUME	PER MBF	** SUM	SUB
Conifers	---	10	X		
Hardwoods	---	10	X		

(18) SPECIAL REQUESTS (Check applicable)

PEELABLE CULL (all species) .....	<input checked="" type="checkbox"/>
<b>NO DEDUCTIONS ALLOWED FOR MECHANICAL DAMAGE</b> .....	<input checked="" type="checkbox"/>
PENCIL BUCK .....	<input type="checkbox"/>
ADD-BACK VOLUME - Deductions due to delay .....	<input checked="" type="checkbox"/>
OTHER:	

- \* Apply minimum volume test to whole logs over 40' Westside; 20' Eastside.  
 \*\* Sum (if indicated): see instructions and explain in Item (19).
- (6) WESTSIDE SCALE: YES  NO   
 Use Region 6 actual taper rule. Logs over 40'.
- (7) EASTSIDE SCALE: YES  NO   
 Use Region 6 actual taper rule. Logs over 40'.
- (8) Weight Scale Sample    
 (6) - (8), pink log load receipts
- (9) Weight Sale
- (10) Per Load    
 (9) and (10), yellow log load receipts

(19) REMARKS \_\_\_\_\_  
 \_\_\_\_\_  
 \_\_\_\_\_  
 \_\_\_\_\_  
 \_\_\_\_\_  
 \_\_\_\_\_

Operator's Name (Optional inclusion by District): \_\_\_\_\_

(20) SIGNATURES:  
 \_\_\_\_\_ Date  
 Purchaser or Authorized Representative  
 \_\_\_\_\_ Date  
 State Forester Representative  
 \_\_\_\_\_  
 State Forester Representative PRINT NAME

(11) APPROVED SCALING LOCATIONS  
 (as shown on the ODF Approved Locations web-site)

Species	Yard	Truck	Weight

(12) NOTICE OF CANCELLATION OF BRAND:  
 Effective Date: \_\_\_\_\_

Notify the District within one hour when branding or painting is inadequate for quick identification, the receipts are missing, not correctly or completely filled out, and/or when logs presented for scaling are impossible to scale accurately.

EXHIBIT C- SAWMILL GRADE  
INSTRUCTIONS FOR FORM 343-307 (rev. 01/09)

- (1) Check appropriate box. REVISION NUMBER requires comments. CANCELLATION requires Item (12). Complete date.
- (2) Designate Third Party Scaling Organization (TPSO).
- (3) State District office, address and phone.
- (4) Enter Purchaser's business name, address, and phone number as it appears on the Contract.
- (5) Minimum Scaling Specifications. Review Section 2040 or 2045, "Log Removal," of the Contract. Species, or combined species can be separate entries. Information serves as a basis for scaling (see also Items (16) thru (18)), and is required to show existence on the sale. **SUM** (lump sum material). **SUB** (sub-merchantable material). SUB, as used by the State, references that material containing at least 10 bf (net) but less than the lower merchantable net volume limit or grade requirements for other merchantable (Per MBF) entries. Per MBF, SUM, and SUB must be indicated by checking the appropriate column. Species with the same specifications and value are combined into one entry. Per MBF and SUB require scaling therefore complete specifications. SUM need not be scaled, hence no specifications. Loads containing only SUM are to be ticketed if so instructed in Item (19). Mixed loads of SUM, Per MBF and/or subspecies will always be scaled.
- (6) Westside – Region 6 actual taper segment scale. Check Yes or No. Special Service Rules on file with TPSO. See: Segment Scaling and Grading of Long Logs -- All Species -- State Forestry Department Scaling Practices (Westside).
- (7) Eastside – Region 6 actual taper/taper table segment scale. Special Service Rules on file with TPSO. See: Segment Scaling and Grading of Long Logs -- All Species -- State Forestry Department Scaling Practices (Northwest Log Rules Eastside). Items with \* follow U.S. Forest Service Eastside rules.
- (8) Weight Scale Sample – Check box if sale is to be a Weight Scale Sample. All specifics for handling, scaling and processing will be attached or explained in the Remarks section Item (19).
- (9) Weight Sale – Check box if sale is to be sold as a weight sale. Processing procedures from approved locations to TPSO's will be explained in the Remarks section of Item (19).
- (10) Per Load – Check box if volumes on sale are per load. Specific instructions for handling and processing will be fully explained in the Remarks section of Item (19).
- (11) Show scaling locations only applicable to TPSO. Location name should appear as it does on the ODF Approved Scaling Location web site: [http://www.odf.state.or.us/DIVISIONS/management/asset\\_management/ScalingLocation.asp](http://www.odf.state.or.us/DIVISIONS/management/asset_management/ScalingLocation.asp) Locations with scaling and processing directions specific to their location should be on a separate form. Species should be identified if not capable of receiving "all" species. Check appropriate box for either: yard, truck scale, or weight. Refer to the web site listed above for the locations approval status.
- (12) When logging and hauling is complete, recall branding hammers, date and sign where indicated, check CANCELLATION box in Item (1), and send to TPSO.
- (13) Enter sale name and county.
- (14) Enter sale Contract number.
- (15) Enter Oregon's State Brand Registry Number **(REQUIRED)**.
- (16) Show brand assigned to timber sale. One brand only. If more than one brand is assigned to the sale: (1) make separate form for each brand and (2) on each form, explain and show other brand(s) in the Remarks section Item (19).
- (17) Check yes for Paint Required and designate "Orange" for color. Non required removal volumes may sometimes require blue paint.
- (18) Special Requests. These are requests that will be applied to ODF timber sales. All boxes applicable to the timber sales designated in the Exhibit C form must be "marked". If "Other" is indicated, it must contain a description and any necessary comments.
- (19) Use this space to designate any weight conversion factors, per load volumes, weight scale sample instructions or any other explanations to clarify scaling, processing and/or mailing requirements. If additional scaling locations are approved, revise original or current form showing all (old and new) locations. Check REVISION box at top of form and explain under remarks. Route as indicated.
- (20) Require purchaser to sign and date completed form in addition to State Forester Representative, sign and print name on the form.

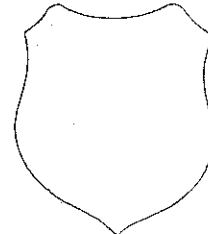
**Salem Distribution Instructions:** Original will be mailed to Salem after it is electronically scanned and e-mailed directly to the State Forests Program/Asset Management Unit to both Timber Revenue Specialists. Scaling instructions for each brand should be scanned separately, for each approved TPSO.

**EXHIBIT C -- PULP SORT**

**SCALING INSTRUCTIONS -- LOCATION APPROVAL -- BRAND INFORMATION**

- (1) ORIGINAL REGISTRATION  Date \_\_\_\_\_  
 REVISION NUMBER \_\_\_\_\_  Date \_\_\_\_\_  
 CANCELLATION  Date \_\_\_\_\_
- (2) TO: \_\_\_\_\_  
 (Third Party Scaling Organization)
- (3) FROM: Tillamook (06) Phone (503) 842-2545  
 (State Forestry District)  
 Address 5005 3<sup>rd</sup> Street, Tillamook, OR 97141
- (4) PURCHASER: \_\_\_\_\_  
 Mailing Address: \_\_\_\_\_  
 Phone Number: \_\_\_\_\_

- (13) SALE NAME: Jack Flash  
 COUNTY: Tillamook
- (14) STATE CONTRACT NUMBER: 341-11-79
- (15) STATE BRAND REGISTRATION NUMBER \_\_\_\_\_
- (16) STATE BRAND INFORMATION: (COMPLETE BELOW)



- (17) PAINT REQUIRED: YES   
 COLOR: Blue

(18) **SPECIAL REQUESTS** (Check applicable)

PEELABLE CULL (all species) .....   
**NO DEDUCTIONS ALLOWED FOR MECHANICAL DAMAGE** .....   
 PENCIL BUCK .....   
 ADD-BACK VOLUME - Deductions due to delay .....   
 OTHER: Convert weight to MBF, using a factor of 10 tons per MBF.

- (19) SPECIAL PROCESSING INSTRUCTIONS: Pulp loads shall be weighed in lieu of scaling. Tons shall be short tons of 2,000 lbs.
- (1) Weigher shall attach a machine-printed weight ticket to the Scaler Receipt part of the STATE Weight Load Receipt and mail them weekly to the approved Third-Party Scaling Organization.
- (2) The TPSO shall notify the Tillamook District office immediately if the above requirement are not met.

Operator's Name (Optional inclusion by District): \_\_\_\_\_

- (20) SIGNATURES:
- \_\_\_\_\_  
 Purchaser or Authorized Representative Date
- \_\_\_\_\_  
 State Forester Representative Date

\_\_\_\_\_  
 State Forester Representative PRINT NAME

(5) MINIMUM SCALING SPECIFICATIONS			CLASS		
SPECIES	SCALING DIAMETER INCHES	*NET SCALE VOLUME	PER MBF	** SUM	SUB
Pulp	By Weight				

\* Apply minimum volume test to whole logs over 40' Westside; 20' Eastside.  
 \*\* Sum (if indicated); see instructions and explain in Item (19).

- (6) WESTSIDE SCALE: YES  NO   
 Use Region 6 actual taper rule. Logs over 40'.
- (7) EASTSIDE SCALE: YES  NO   
 Use Region 6 actual taper rule. Logs over 40'.
- (8) Weight Scale Sample YES  NO   
 (6) - (8), pink log load receipts
- \* (9) Weight Sale YES  NO
- \* (10) Per Load YES  NO   
 (9) and (10), yellow log load receipts

(11) APPROVED SCALING LOCATIONS (as shown on the ODF Approved Locations web-site)	Species	Yard	Truck	Weight

- (12) NOTICE OF CANCELLATION OF BRAND:  
 Effective Date: \_\_\_\_\_

**Notify the District within one hour when branding or painting is inadequate for quick identification, the receipts are missing, not correctly or completely filled out, and/or when logs presented for scaling are impossible to scale accurately.**

EXHIBIT C- PULP SORT  
INSTRUCTIONS FOR FORM 343-307 (rev. 01/09)

- (1) Check appropriate box. REVISION NUMBER requires comments. CANCELLATION requires Item (12). Complete date.
- (2) Designate Third Party Scaling Organization (TPSO).
- (3) State District office, address and phone.
- (4) Enter Purchaser's business name, address, and phone number as it appears on the Contract.
- (5) Minimum Scaling Specifications. Review Section 2040 or 2045, "Log Removal," of the Contract. Species, or combined species can be separate entries. Information serves as a basis for scaling (see also Items (16) thru (18)), and is required to show existence on the sale. **SUM** (lump sum material). **SUB** (sub-merchantable material). SUB, as used by the State, references that material containing at least 10 bf (net) but less than the lower merchantable net volume limit or grade requirements for other merchantable (Per MBF) entries. Per MBF, SUM, and SUB must be indicated by checking the appropriate column. Species with the same specifications and value are combined into one entry. Per MBF and SUB require scaling therefore complete specifications. SUM need not be scaled, hence no specifications. Loads containing only SUM are to be ticketed if so instructed in Item (19). Mixed loads of SUM, Per MBF and/or subspecies will always be scaled.
- (6) Westside – Region 6 actual taper segment scale. Check Yes or No. Special Service Rules on file with TPSO. See: Segment Scaling and Grading of Long Logs – All Species – State Forestry Department Scaling Practices (Westside).
- (7) Eastside – Region 6 actual taper/taper table segment scale. Special Service Rules on file with TPSO. See: Segment Scaling and Grading of Long Logs – All Species – State Forestry Department Scaling Practices (Northwest Log Rules Eastside). Items with \* follow U.S. Forest Service Eastside rules.
- (8) Weight Scale Sample – Check box if sale is to be a Weight Scale Sample. All specifics for handling, scaling and processing will be attached or explained in the Remarks section Item (19).
- (9) Weight Sale – Check box if sale is to be sold as a weight sale. Processing procedures from approved locations to TPSO's will be explained in the Remarks section of Item (19).
- (10) Per Load – Check box if volumes on sale are per load. Specific instructions for handling and processing will be fully explained in the Remarks section of Item (19).
- (11) Show scaling locations only applicable to TPSO. Location name should appear as it does on the ODF Approved Scaling Location web site: [http://www.odf.state.or.us/DIVISIONS/management/asset\\_management/ScalingLocation.asp](http://www.odf.state.or.us/DIVISIONS/management/asset_management/ScalingLocation.asp) Locations with scaling and processing directions specific to their location should be on a separate form. Species should be identified if not capable of receiving "all" species. Check appropriate box for either: yard, truck scale, or weight. Refer to the web site listed above for the locations approval status.
- (12) When logging and hauling is complete, recall branding hammers, date and sign where indicated, check CANCELLATION box in Item (1), and send to TPSO.
- (13) Enter sale name and county.
- (14) Enter sale Contract number.
- (15) Enter Oregon's State Brand Registry Number **(REQUIRED)**.
- (16) Show brand assigned to timber sale. One brand only. If more than one brand is assigned to the sale: (1) make separate form for each brand and (2) on each form, explain and show other brand(s) in the Remarks section Item (19).
- (17) Check yes for Paint required and designate color being used. Non-required removal volumes may *sometimes* require blue paint.
- (18) Special Requests. These are requests that will be applied to ODF timber sales but are *not* applicable to non-scale materials. Special requests boxes must be "marked" if they apply to the timber sale, designated in the Exhibit C scaling instructions form. If "Other" is indicated, it must contain a description and any necessary comments.
- (19) Use this space to designate any weight conversion factors, per load volumes, weight scale sample instructions or any other explanations to clarify scaling, processing and/or mailing requirements. If additional scaling locations are approved, revise original or current form showing all (old and new) locations. Check REVISION box at top of form and explain under remarks. Route as indicated.
- (20) Require purchaser to sign and date completed form in addition to State Forester Representative, sign and print name on the form.

**Salem Distribution Instructions:** Original will be mailed to Salem after it is electronically scanned and e-mailed directly to the State Forests Program/Asset Management Unit to both Timber Revenue Specialists. Scaling instructions for each brand should be scanned separately, for each approved TPSO.

EXHIBIT D  
 FOREST ROAD SPECIFICATIONS

SUBGRADE WIDTH (feet)	SURFACED WIDTH (feet)	POINT TO POINT	STATION TO STATION	DRAINAGE	DITCH TOP WIDTH (Feet)	DITCH CONFIGURATION (U, V, TRAPAZOID)	DITCH DEPTH FROM SUBGRADE (Feet)
20	18	A to B	0+00 to 1+00	Outslope	-----	-----	-----
14	12	A to B	1+00 to 15+40	Outslope	-----	-----	-----
14	-----	A to B	15+40 to 20+90	Outslope	-----	-----	-----
14	12	C to D	0+00 to 1+00	Outslope	-----	-----	-----
14	-----	C to D	1+00 to 7+95	Outslope	-----	-----	-----
14	-----	E to F	0+00 to 4+45	Outslope	-----	-----	-----
Existing	Existing	G to H	0+00 to 2+75	Existing	3	V	1
20	18	I to J	0+00 to 1+00	Existing	-----	-----	-----
Existing	Existing	I to J	1+00 to 6+70	Existing	-----	-----	-----
14	-----	I to J	6+70 to 19+65	Outslope	-----	-----	-----
14	-----	K to L	0+00 to 9+30	Outslope	-----	-----	-----
14	-----	M to N	0+00 to 11+60	Outslope	-----	-----	-----
Existing	Existing	O to P	0+00 to 1+60	Existing	-----	-----	-----
Existing	Existing	Q to R	0+00 to 134+50	Existing	3	V	1
Existing	Existing	Q to R	134+50 to 158+40	Ditch	3	V	1
20	18	S to T	0+00 to 1+00	Existing	-----	-----	-----
Existing	Existing	S to T	1+00 to 21+20	Existing	-----	-----	-----
14	-----	S to T	21+20 to 40+85	Outslope	-----	-----	-----

**CLEARING.** This work shall consist of clearing, removing, and disposing of all trees, Snags, Down Timber, brush, surface objects, and protruding obstructions within the clearing limits.

Where clearing limits have not been marked, the "Road Brushing Specifications" in Exhibit D shall apply. Clearing debris shall not be placed or permitted to remain in or under any road embankment sections. Clearing debris shall not be left lodged against standing trees.

All danger trees, leaners, and Snags outside the clearing limits which could fall and hit the road shall be felled.

**GRUBBING.** This work shall consist of the removal or digging out of stumps and protruding objects.

All stumps shall be completely removed within the limits of required grubbing. Stumps overhanging cutslopes shall be removed. Grubbing debris shall not be placed or permitted to remain in or under any road embankment sections. Grubbing debris shall not be left lodged against standing trees. Grubbing classifications are as follows:

New construction - From the top of the cutslope to the toe of the fill.



EXHIBIT D  
FOREST ROAD SPECIFICATIONS

Improvements - 4 feet back from the shoulder of the subgrade or the ditch, whichever is widest, or as marked in the field.

Trees outside the clearing limits shall not be felled unless approved in writing by STATE.

CLEARING AND GRUBBING DISPOSAL. Clearing and grubbing debris shall not be left lodged against standing trees. Clearing and grubbing debris may be scattered through openings in the timber outside of the cleared right-of-way, except for the following areas, where debris shall be fully contained and hauled to a designated waste area.

- Where end-haul is required.
- On side slopes exceeding 55 percent.
- On unstable areas.
- In any stream channel (Type F, N or D) or where material may enter the stream channel.

Clearing and grubbing disposal shall be completed prior to subgrade approval.

EXCAVATION. Excavation and grading shall not be done when weather and/or ground conditions are such that damage will result to existing subgrade or cause excessive erosion.

Excavation shall conform to STATE-engineered lines, grades, dimensions, and plans when provided.

All suitable excavated material shall be used where possible for the formation of fills, shoulders, and drainage structure backfills. Embankment materials shall be free of woody debris, brush, muck, sod, frozen material, and other deleterious materials. All fills and drainage structure backfills shall be machine compacted according to the specifications in Exhibit D and G.

Unless road design plans show otherwise, all roads shall be on a balanced cross section, except when the slope is over 55 percent, the road shall be on full bench for the width specified.

Excess excavation shall not be sidecast where material will enter a stream course or where material will accumulate in areas deemed a high landslide hazard location by STATE.

EXHIBIT D  
FOREST ROAD SPECIFICATIONS

ROAD WIDTH LIMITATIONS. PURCHASER shall obtain advance written approval from STATE to construct the road to a greater width than specified. Extra subgrade width shall be required for:

Fill Widening. Add to each fill shoulder 1 foot for fills 3 feet to 6 feet high; 2 feet for fills over 6 feet high.

Curve Widening. Widen the inside shoulder of all curves as follows: 400 divided by the radius of the curve equals the amount of extra width.

DRAINAGE

Ditch. Construct ditch as specified in Exhibit D. Subgrade shall be crowned at 4 to 6 percent.

Outslope. Road subgrade shall be outsloped at 4 to 6 percent.

TURNOUTS. Increase roadbed width an additional 8 feet for both subgrade and surfacing. Length shall be at least 25 feet, or as staked on the ground, plus 25-foot approaches at each end.

Location: Intervisible but not greater than 750 feet.

GRADING

Rock  
Common -

Back Slopes  
Vertical to 1/4:1  
3/4:1

Fill Slopes  
Not steeper  
than 1 1/2:1

Top of cutslope shall be rounded.

LANDING Landings shall be constructed as posted in the field, no less than 50 feet wide and no more than 70 feet wide. These distances shall utilize the width of the existing roads. Surfaced shall be crowned for drainage.

TURNAROUNDS. Increase subgrade width an additional 30 feet for a length of 16 feet with 20' radius returns at locations marked in the field.

EXHIBIT D  
ADDITIONAL ROAD IMPROVEMENT INSTRUCTIONS  
END-HAULING REQUIREMENTS

POINT TO POINT	STA. TO STA.
A to B	3+05 to 6+05
I to J	9+25 to 11+95 12+50 to 13+65
S to T	24+24 to 25+10 26+15 to 29+10

End-Haul Areas General Requirements

Material shall not be intentionally side cast.

Clearing and grubbing debris shall be end-hauled.

When blasting is required, it shall be accomplished using timing devices, delayed charges, low intensity shots, or other suitable means to contain all material within the road prism.

Containment

Full containment: The amount of material lost over the outside edge of the road shall not exceed 6 inches in depth measured perpendicular to the natural ground slope. Pioneer excavation shall be removed by digging, loading, and hauling rather than by pushing or scraping methods.

Tree bases and stumps may have up to 12 inches of material directly above them. Any amount of material exceeding the containment requirements shall be removed by whatever means necessary and end-hauled to a designated waste area.

Waste Area Location

As shown on Exhibit A and as marked in the field.

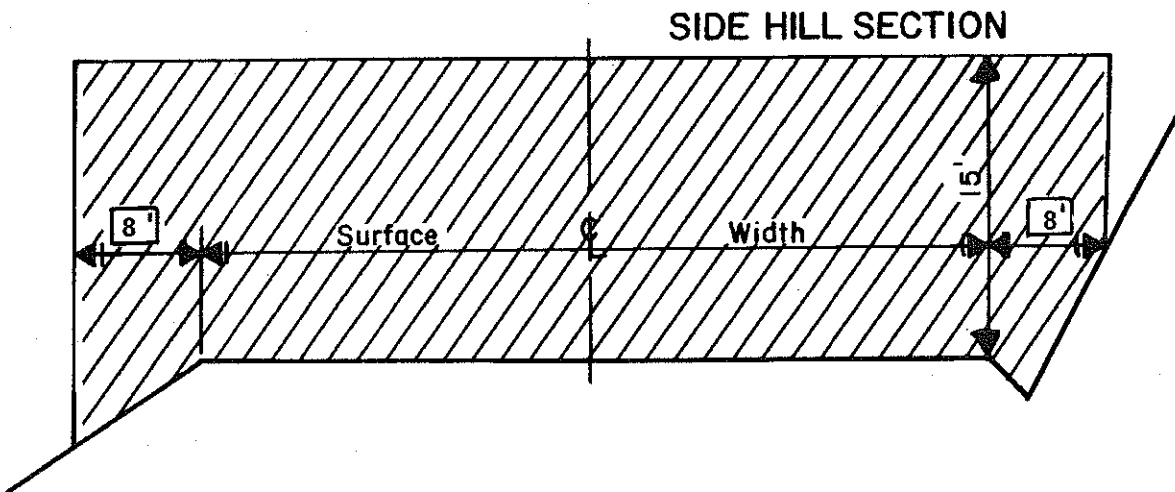
Waste Area Treatment

Deposit at waste areas, spread evenly, compact, and provide adequate drainage. Pile woody debris separate from other waste material.

EXHIBIT D  
ROAD BRUSHING SPECIFICATIONS



Clearing Limits



REQUIREMENTS

Unless otherwise approved in writing by STATE, brush and trees shall be cut to a height of 6 inches or less above the ground surface or obstructions such as rocks or existing stumps. Brushing on project road segments shall be completed prior to subgrade approval. Trees shall not be felled unless a portion of the bole is within the clearing limits.

Debris resulting from the brushing operation shall be removed from the roadway, cutslope, ditches, and water courses within 72 hours and may be scattered downslope from the road or placed in other stable locations, unless otherwise approved by STATE.

Trees outside the clearing limits shall not be felled unless approved in writing by STATE.

EXHIBIT E  
 ROAD SURFACING

ROAD SEGMENT:		A to B		STATIONS:		0+00		to		15+40	
Application	Rock Size and Type	Compacted Depth		Volume (CY) per		Number of Units	Curve Widening (CY)	Approx. Total (CY)			
Road Rock	Crushed 4"-0"	9 "		station	47.4	15.4	40	770			
Turnouts	Crushed 4"-0"	9 "		TO	20	3		60			
Application	Rock Size and Type	Approx. Total (CY)									
Junction Rock	Crushed 4"-0"	20									
Bedding/Backfill	Crushed 2 1/2"-0"	10									

ROAD SEGMENT:		C to D		STATIONS:		0+00		to		1+00	
Application	Rock Size and Type	Compacted Depth		Volume (CY) per		Number of Units	Curve Widening (CY)	Approx. Total (CY)			
Road Rock	Crushed 4"-0"	9 "		station	50	1	10	60			
Turnouts	Crushed 4"-0"	9 "		TO	20	1		20			

ROAD SEGMENT:		G to H		STATIONS:		0+00		to		2+75	
Application	Rock Size and Type	Compacted Depth		Volume (CY) per		Number of Units	Curve Widening (CY)	Approx. Total (CY)			
Road Rock	Crushed 4"-0"	9		station	50.91	2.75	10	150			
Turnouts	Crushed 4"-0"	9		TO	20	1		20			
Application	Rock Size and Type	Approx. Total (CY)									
Fill Armor	Riprap 48"-24"	20									
Embankment Fill	Crushed 4"-0"	10									
Bedding/Backfill	Crushed 2 1/2"-0"	20									

ROAD SEGMENT:		I to J		STATIONS:		0		to		100	
Application	Rock Size and Type	Compacted Depth		Volume (CY) per		Number of Units	Curve Widening (CY)	Approx. Total (CY)			
Road Rock	Crushed 4"-0"	9		station	50	1	10	60			
Turnouts	Crushed 4"-0"	9		TO	20	1		20			
Application	Rock Size and Type	Approx. Total (CY)									
Junction Rock	Crushed 4"-0"	20									

EXHIBIT E  
 ROAD SURFACING

ROAD SEGMENT:		Q to R		STATIONS:		0		to		15840	
Application	Rock Size and Type	Compacted Depth		Volume (CY) per	Number of Units	Curve Widening (CY)	Approx. Total (CY)				
Road Rock	Crushed 2 1/2"-0"	6		station	30.745	158.40	220	5090			
Turnouts	Crushed 2 1/2"-0"	6		TO	20	22		440			
Application	Rock Size and Type	Approx. Total (CY)									
Culvert Backfill	Crushed 2 1/2"-0"	10									

ROAD SEGMENT:		S to T		STATIONS:		0+00		to		1+00	
Application	Rock Size and Type	Compacted Depth		Volume (CY) per	Number of Units	Curve Widening (CY)	Approx. Total (CY)				
Road Rock	Crushed 4"-0"	9 "		station	50	1	10	60			
Turnouts	Crushed 4"-0"	9 "		TO	20	1		20			
Application	Rock Size and Type	Approx. Total (CY)									
Culvert Backfill	Crushed 2 1/2"-0"	10									
Culvert Backfill	Crushed 2 1/2"-0"	10									
Junction Rock	Crushed 4"-0"	20									

TOTAL ROCK	2 1/2"-0" CRUSHED	4"-0" CRUSHED	48"-24" RIPRAP
6,920 CY	5,590 CY	1,310 CY	20 CY

Roads shall be uniformly graded and approved by STATE prior to rocking. Additional rock for curve widening is required and has been included in the volume estimates. Turnouts, turnarounds, landings and junctions shall be rocked concurrently with the road. End-dumping of riprap shall not be allowed, unless otherwise approved in writing by STATE. Any additional turnarounds or turnouts created during any operation associated with this timber sale shall be rocked at PURCHASER's expense and as instructed by STATE.

Roads shall be uniformly graded and approved by STATE prior to rocking. For typical cross section, turnout and turnaround see Forestry Department Drawing Nos. 351-C, 351-D and TOTA-1 at the Forestry Department district office.

Materials. The material shall be well graded and consistent.

Quality and Grading Requirements. The stone base materials shall be crushed rock. River gravel shall not be used.

EXHIBIT E

CRUSHED ROCK SPECIFICATIONS

- (1) For the purpose of crushing rock specified under the projects in Section 2610, "Project Work," PURCHASER shall utilize a three-stage rock crusher, or equivalent, unless otherwise approved by STATE.

The rock crusher shall be calibrated to produce rock as specified in Exhibit E. Prior to the commencement of production crushing, PURCHASER shall sample, test, and provide rock test results meeting STATE specifications. STATE may then sample and test crushed rock for approval to proceed. PURCHASER shall take one sample of each 1,000 cubic yards of crushed rock material produced thereafter, using approved AASHTO sampling procedures. PURCHASER shall submit samples to a certified laboratory or shall perform testing for gradation requirements using AASHTO T 11 and AASHTO T 27 testing procedures. Prior to testing, each sample shall be split, making one-half of the sample, with proper identification, available for testing by STATE. Each sample and the results of PURCHASER testing shall be made available to STATE within 24 hours of sampling. Any rock crushed prior to STATE approval to proceed shall not be credited to the required rock quantity. Any subsequent rock tests not meeting STATE specifications shall be reason for rejection of that portion of crushed rock produced after that test and shall not be credited to the required rock quantity. STATE may sample the crushed rock at any time during the operation. Results of STATE's tests shall prevail over all other test results.

- (2) Standard gradation specifications for marginal durability base or single course aggregate (fewer fines).

Sieve size	Percent Passing	
	4 inch	2 1/2 inch
4	95-100	--
3	--	100
2 1/2	70-90	95-100
1 1/4	--	50-70
1/4 or #4	15-50	25-40
#10	0-30	40-60
#40	0-10	--

48" - 24" Riprap

50% or more of the rock shall be at 48 inches in one dimension. 100% of the rock shall be at least 24 inches in one dimension.

Control of riprap shall be by visual inspection by STATE.

The referenced sieve shall have square openings as set forth in AASHTO M 92, Woven Cloth Series. The determinations of size and gradings shall be as set forth in AASHTO T 27.

EXHIBIT E  
ROCK ACCOUNTABILITY

**Purchaser shall obtain STATE approval for subgrades prior to rocking.** Rocking must be done only when weather conditions are acceptable to STATE, and must be suspended when muddy water could enter streams.

Rock accountability shall be determined by the following methods, as directed by STATE. STATE shall be given 24 hours' notice prior to rocking.

Depth Measurement. Road rock shall be spread and compacted according to the depths specified in Exhibit E or as directed by STATE. Truck measure volumes are given, but shall not limit the amount of rock spread.

Depth shall be determined in the most compacted area of the surface cross section. If additional rock is required because of insufficient depth, it shall be added by truck measure to those areas that were slighted. The conversion from compacted yardage to truck yardage is 1.3 multiplied by the compacted yardage equals truck yardage.

The depth of compacted aggregates shall not vary more than 1 inch from the depth specified in Exhibit E. The average depth for each road segment shall be the specified depth or greater.

Junctions shall have a surfaced area of at least 175 square yards each at the compacted depths specified in Exhibit E.

Turnouts shall have a surfaced area of at least 44 square yards each at the depths shown in Exhibit E.

Turnarounds shall have a surfaced area of at least 73 square yards each at the depths shown in Exhibit E.

Landings shall have a minimum surfaced area of at least 220 square yards each at the depths shown in Exhibit E.

Curve Surfacing. Extra surface width shall be required for the inside of all curves as follows: 400 divided by the radius of the curve equals the amount of extra width to be surfaced at the depths shown in Exhibit E.



EXHIBIT E

COMPACTION AND PROCESSING REQUIREMENTS

**Subgrade.** Subgrade surfaces of the road segments listed below shall be graded and compacted prior to rocking. Compaction shall be accomplished by traveling all surfaces from shoulder to shoulder until visible deformation ceases, or in the case of a sheepsfoot roller, the roller "walks out." At least 3 passes shall be made over the entire width and length of the road. A pass is defined as traveling a road section in one direction and then back over that same section again. Compaction shall be accomplished by using the approved equipment listed below or others approved by STATE.

ROAD SEGMENT	COMPACTION EQUIPMENT OPTIONS
A to B (0+00 to 15+40), C to D (0+00 to 1+00), G to H, S to T (0+00 to 1+00)	Vibratory Roller

**Fills.** Embankments and fills shall be placed in (approximately) horizontal layers not more than 8 inches in depth. Each layer shall be separately, and thoroughly, compacted. Compaction equipment shall be operated over the entire width of each layer until visible deformation of the layers ceases or, in the case of a sheepsfoot roller, the roller "walks out." At least 3 passes shall be made over the entire width and length of each layer. A pass is defined as traveling a fill layer in one direction and then back over that same layer again.

Placing individual rocks or boulders with more depth than the allowed layer thickness shall be permitted, provided the embankment will accommodate them. Such rocks and boulders shall be at least 6 inches below the subgrade. They shall be carefully distributed and the voids filled with finer material, forming a dense and compacted mass. Compaction shall be accomplished by using the approved equipment listed below or others approved by STATE:

ROAD SEGMENT	COMPACTION EQUIPMENT OPTIONS
A to B, C to D, E to F, I to J (6+70 to 19+65), K to L, M to N, S to T 921+20 to 40+85)	Crawler Tractor

**Crushed Rock.** The rock shall be uniformly mixed and spread in layers on the approved roadbed. Each layer of crushed rock shall be moistened or dried to a uniform moisture content suitable for maximum compaction and compacted in layers not to exceed 6 inches in depth. When more than 1 layer is required, each shall be shaped and compacted before the succeeding layer is placed. Any irregularities or depressions that develop during compaction of the top layer shall be corrected by loosening the material at these places and adding or removing material until the surface is smooth and uniform. Each layer shall be compacted with a minimum of 3 passes over the entire width and length of the road. A pass is defined as traveling a road section in one direction and then back over that same section again. Compaction shall be accomplished by using the approved equipment listed below or others approved by STATE:

Rock shall be compacted and processed during the same project period it is spread, unless otherwise approved in writing by STATE.

Rock shall be crowned at 4 to 6 percent unless otherwise specified.

ROAD SEGMENT	COMPACTION EQUIPMENT OPTIONS
C to D (0+00 to 1+00)	Vibratory Roller and/or
I to J (0+00 to 1+00), S to T (0+00 to 1+00)	Rock Trucks
A to B (0+00 to 15+40), Q to R	Vibratory Roller

## EXHIBIT E

### COMPACTION AND PROCESSING REQUIREMENTS

Existing Crushed Rock (Q to R). The existing rock shall be unearthed to a minimum depth of 4 inches or to 1 inch below the bottom of potholes, whichever is greater. The existing rock shall then be uniformly mixed and moistened or dried to a uniform moisture content suitable for maximum compaction and compacted. Any irregularities or depressions that develop during compaction shall be corrected by loosening the material at these places and adding or removing material until the surface is smooth and uniform. The existing rock shall be compacted with a minimum of 3 passes over the entire width and length of the road. A pass is defined as traveling a road section in one direction and then back over that same section again. Compaction shall be accomplished by using the approved equipment listed below or others approved by STATE:

### COMPACTION EQUIPMENT OPTIONS

Vibratory Rollers. The drum shall have a smooth surface, a diameter not less than 48 inches, a width not less than 58 inches, and a turning radius of 15 feet or less. Vibration frequency shall be regulated in steps to 1400, 1500, and 1600 VPM, corresponding to engine speeds of 1575, 1690, and 1800 RPM. The centrifugal force developed shall be 7 tons at 1600 VPM. It shall be activated by a power unit of not less than 25 horsepower. The vibratory roller shall be self-propelled and operated at speeds ranging from 0.9 miles to 1.8 miles per hour, as directed by STATE.

Vibratory Hand-Operated or Backhoe-Mounted Tamper. Vibratory hand-held or hydraulic tampers shall be used for compaction of backfill materials around culverts (and/or bridge approach embankment materials around abutments). The tamper shoe dimensions shall be a minimum of 10" X 13" and capable of a centrifugal force of 2,250 pounds.

Dump Trucks Dump truck shall be at least a 10-12 CY Highway Dump in size. Rock spreading shall begin at the nearest point to the rock source and progress toward the end of the project. Rock trucks shall be routed over the entire cross section of rock layers.

Crawler Tractors. D-7 Caterpillar or equivalent.

EXHIBIT F

ROCK PIT DEVELOPMENT AND USE

- (1) PURCHASER shall conduct the Operations relative to the disposal of waste material in such manner that silt, rock, debris, dirt, or clay shall not be washed, conveyed, or otherwise deposited in any stream. All waste shall be deposited at an approved "waste disposal site."
- (2) Where overburden removal limits have not been marked, they shall extend for a distance of at least 20 feet beyond the developed rock source. Overburden removal limits, when marked, are designated by orange right-of-way boundary tags. Overburden and woody debris shall be hauled to a designated waste area. All merchantable timber shall be felled and decked. Overburden shall be spread evenly, grass seeded, and compacted at the waste area and woody debris stacked separately. Prior to drilling or rock removal, completion of overburden removal shall be approved in writing by STATE.
- (3) The rock pit floor shall be developed to provide drainage away from the rock pit. Rock pit drainage ditches shall be developed and maintained. Benches shall be constructed at intervals of 40 feet or less in height and shall be a minimum of 20 feet in width. Any gravel or talus slopes shall be left with a working face at an angle of 60 degrees or less. There shall be a minimum of 1 bench with an access road to it. All benches shall have an access road to them. Said benches shall be easily accessible with tractors. All accesses and benches shall be left free and clear of unused shot rock material and dirt. Unused shot rock material shall be piled in pit area designated by STATE. Dirt (overburden) shall be hauled to designated waste area.
- (4) The STATE shall be notified two working days prior to the beginning of drilling operations. Working days shall be defined as Monday through Friday, 6:00 a.m. to 2:30 p.m.
- (5) Controlled blasting techniques shall be utilized for any blasting operations, and shall be accomplished using timing devices, delayed charges, low intensity shots, or other suitable means to contain all material in the rock pit prism (full containment). Each low intensity shot shall be shot into the previous shots' void in order to contain all the material in the rock pit prism. Each shot shall also have a "tattle-tale" end cap so that it is known if all charges were detonated. The purchaser shall detonate or remove all non-detonated explosives from STATE LANDS. PURCHASER shall maintain a comprehensive log that contains all pertinent data for all blasting operations. The blasting log shall be submitted to the STATE after the completion of all blasting activity. The blasting log is intended for STATE record keeping purposes only.
- (6) Pit face shall be developed in a uniform manner.
- (7) Oversized material that is produced shall be piled in the vicinity of the pit. It shall not be wasted.
- (8) PURCHASER shall prepare a written development plan for the pit area. The plan shall be submitted to STATE for approval prior to conducting any operation in the pit area.

The plan shall include, but not be limited to:

- (a) Location of benches and roads to benches.
  - (b) Disposal site for debris and overburden.
  - (c) Time lines for rock quarry use.
  - (d) Erosion control measures.
  - (e) Oversized material location.
- (9) PURCHASER shall schedule and coordinate quarry and stockpile usage with other existing or planned STATE contracts requiring quarry and stockpile usage.
  - (10) PURCHASER shall notify STATE 5 days prior to the start of quarry development activities.
  - (11) Upon completion of use, the pit site and access roads shall be left in a condition free from overburden and debris. Rock pit roads shall be waterbarred to provide drainage as specified in Exhibit K and blocked as directed by STATE.

EXHIBIT G  
CULVERT SPECIFICATIONS

All culvert materials shall be furnished and installed by PURCHASER, unless otherwise specified in the Contract. Culverts shall be constructed of corrugated aluminized steel. Culverts shall conform to the material and fabricating requirements of the "Standard Specifications for Highway Construction" prepared by the Highway Division of the Oregon State Department of Transportation. Corrugation types and shapes other than those meeting the above minimum Highway requirements shall be approved in writing by STATE.

Culverts shall be located according to the alignment and grade as shown on the Plan and Profile, and/or as staked in the field, or as stipulated in special instructions.

The STATE Representative shall determine final culvert locations and stake the locations in the field prior to installation.

Culvert grade shall slope away from ditch grade at least 5 percent unless otherwise specified.

The foundation and trench walls for all culverts shall be free from logs, stumps, limbs, stones, and other objects which would dent or damage the pipe. The culvert trench shall be excavated 3 pipe diameters wide to permit compaction and working on each side of the pipe. Tamping shall be done in 6-inch lifts, 1 pipe diameter each side of the pipe to 95 percent density or over. Bedrock shall be excavated as required to provide a uniform foundation for the full length of the culvert. Minimum bedding depth shall be 6 inches.

A bedding of granulated material or crushed rock as specified shall be placed to provide a wide band of support and to transmit the load from above evenly over the entire length of the pipe.

Backfill shall consist of granulated material, crushed rock, or job-excavated soil free of stumps, limbs, rocks, or other objects which would damage the pipe.

Transporting of the pipe shall be done carefully. Dragging or allowing free fall from trucks or into trenches shall not be permitted.

Joining shall be done with bands of like material and corrugations. Manufacturers' instructions shall be followed for prefabricated pipe assembly.

When joints are employed, the longest length of pipe shall be placed at the outlet end.

A manufacturer's certification that the product was manufactured, tested, and supplied in accordance with this specification shall be furnished to the State's Contract Administrator upon request.

Minimum height of cover over top of culvert to subgrade when road is to be rocked shall be 12", add 6" for roads which will not be rocked. Minimum vertical cover for other designs shall be as specified by STATE.

Lengths of individual culvert sections shall be not less than 10 feet, unless otherwise provided for in special instructions. The shortest culvert section length shall be placed at the inlet end.

The ends of each culvert shall be free of logs and debris which would restrict the free flow of water. The intake end of relief culverts shall be provided with a sediment catching basin 3 feet in diameter at the bottom. The outlet end of any culvert which would allow water to erode embankment soil shall be provided with an approved slope protection device. Construct lead-off ditches away from culvert outlets where the slope gradients restrict the free flow of water.

EXHIBIT G  
 CULVERT SPECIFICATIONS

Following are the minimum standard gauges for steel culvert and coupling bands. Some culverts may require different gauges and may be found in the culvert listing.

<u>Dia.</u>	<u>Steel Culvert</u>		<u>Thickness</u>		<u>Band Gauges</u>	<u>Band Widths (")</u>	
	<u>Gauge</u>		<u>Uncoated</u>	<u>Coated</u>		<u>Annular</u>	<u>Helical</u>
18-36	16		(0.0598")	(0.064")	16	12	12

CULVERT LIST

CULVERT NO.	DIAMETER (Inches)	LENGTH (Feet)	ROAD SEGMENT Point to Point	STATION
1	18	30	A-B	13+60
2	36	36	G-H	1+00
3	24	36	G-H	2+20
4	18	34	Q-R	0+15
5	24	30	S-T	25+30
6	36	30	S-T	39+70

Culverts shall be marked by installing a 5 foot long, painted steel fence post two feet into the ground, within 6 inches of the inlet on the downgrade side.

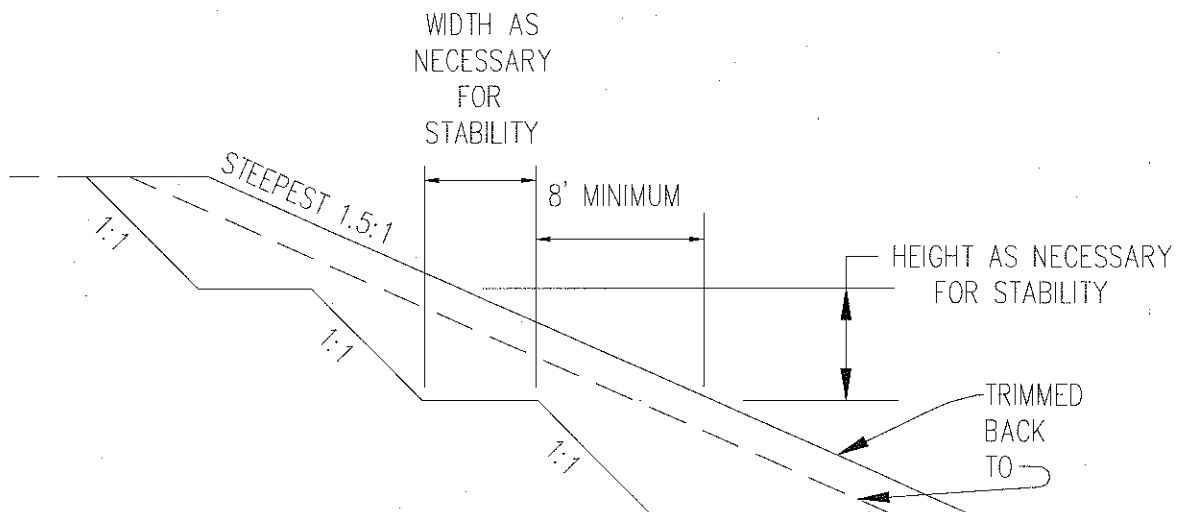
Tamping is required on all culverts. Backfills on culverts over 30 inches in diameter shall be compacted with a vibratory hand-operated or Backhoe mounted tamper.

All culverts scheduled for replacement shall become property of PURCHASER and be removed from State land in the same project period in which replacement occurred.

EXHIBIT H  
FILL CONSTRUCTION SPECIFICATIONS

(no scale)

ALL TEMPORARY EARTH SLOPES SHALL COMPLY WITH OR-OSHA REQUIREMENTS. AREAS TO RECEIVE STRUCTURAL FILL THAT HAVE A SLOPE GREATER THAN 5 HORIZONTAL FEET TO 1 VERTICAL FOOT SHALL HAVE HORIZONTAL BENCHES AND KEYWAYS CUT INTO THE FILL AREAS PRIOR TO PLACING THE NEW FILLS. ALL FILL MATERIAL SHALL BE PLACED AS STRUCTURAL FILL BEYOND 1.5H:1V SLOPE AND THEN BE TRIMMED BACK TO A 1.5H:1V SLOPE SO THAT COMPACTED FILL IS EXPOSED ON THE FACE OF THE SLOPE (SEE DETAIL BELOW).



DETAIL: BENCHING AND SIDEHILL EMBANKMENT FILL CONSTRUCTION

THE STATE SHALL BE CONTACTED TO OBSERVE THE FINAL CUT AND FILL SLOPE CONFIGURATIONS AND CONDITIONS TO COMMENT ON THE NEED FOR FURTHER GRADING OR SLOPE STABILIZATION METHODS BASED ON THE FINAL GRADING CONDITIONS.

ONCE OBSERVED BY THE STATE, EROSION CONTROL MEASURES SHALL BE APPLIED TO THE GRADED SLOPES.

EXHIBIT I  
SEEDING AND FERTILIZING

This work shall consist of preparing seedbeds and furnishing and placing required seed and fertilizer.

Seeding Seasons. Seeding shall be performed only from March 1 through June 15 and August 15 through October 15. Seeding materials shall not be applied during windy weather or when the ground is excessively wet or frozen. Areas of disturbed soil shall be seeded by the end of the project period in which work was started. PURCHASER shall notify STATE 24 hours prior to seeding.

Soil Preparation. Areas to be seeded that have been damaged by erosion or other causes shall be restored prior to seeding. All areas to be seeded shall be finished and then cultivated to provide a reasonably firm, but friable seedbed. A minimum of 1/2 inch of surface soil shall be in a loose condition.

Application Methods for Seed and Fertilizer

Dry Method. Mechanical seeders, seed drills, landscape seeders, cultipacker seeders, fertilizer spreaders or other approved mechanical seeding equipment shall be used to apply the seed and fertilizer in the amounts and mixtures specified. Hand-operated seeding devices may be used when seed and fertilizer are applied in dry form.

Application Rates for Seed and Fertilizer

Seed listed below shall be applied at the following rates per acre:

<u>Species</u>	<u>Lb./Acre</u>	<u>Mixture</u>	<u>Pure Live Seed</u>	<u>Poison and/or Repellent</u>
Fine Fescue	12	40%	98%	0
Annual Ryegrass	6	20%	98%	0
Perennial Ryegrass	9	30%	98%	0
White Dutch Clover	3	10%	98%	0

Fertilizer: Chemical analysis shall be 16-20-0 and shall be applied at the rate of 300 pounds per acre.

Seeding will be considered acceptable when all other specified requirements in Exhibit I and J have been completed and a healthy, uniform, close stand of grass has been established, unless otherwise approved in writing by STATE.

State Timber Sale Contract  
No. 341-11-79  
Jack Flash

EXHIBIT J

MULCHING

This work shall consist of furnishing and placing required mulch. Mulch shall consist of straw that is free of noxious weeds.

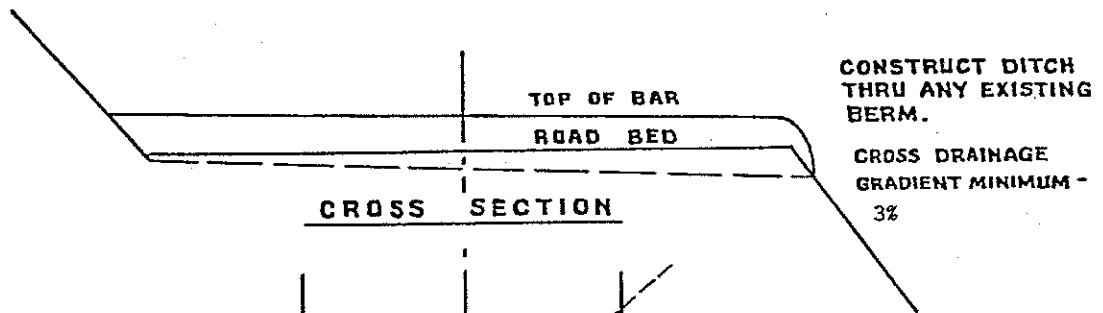
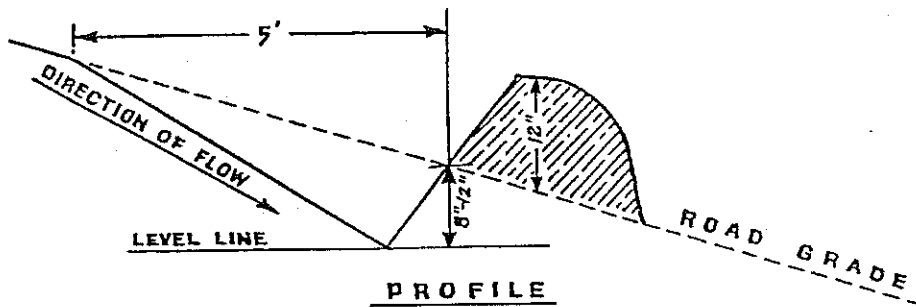
Mulching Period. Straw mulch shall be applied within 24 hours of spreading grass seed and fertilizer.

Application Rates for Mulch

Place straw mulch to a reasonably uniform thickness of  $\frac{3}{4}$  to  $1\frac{1}{4}$  inches. This rate requires between 1 and  $1\frac{1}{2}$  tons of dry mulch per acre.

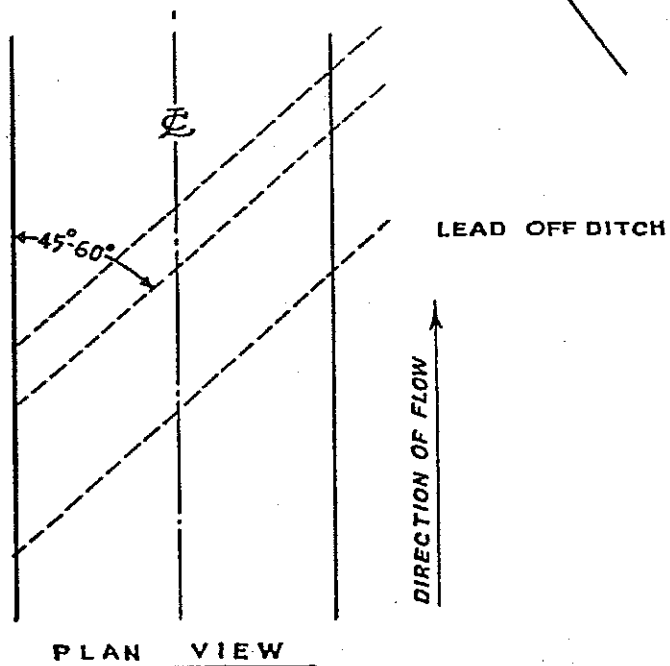


EXHIBIT K  
 WATERBAR SPECIFICATIONS



**SPACING OF WATERBARS**

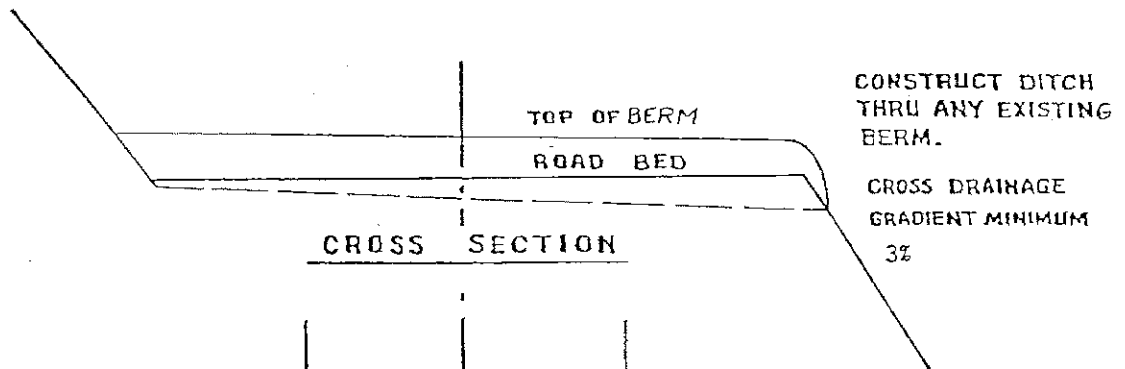
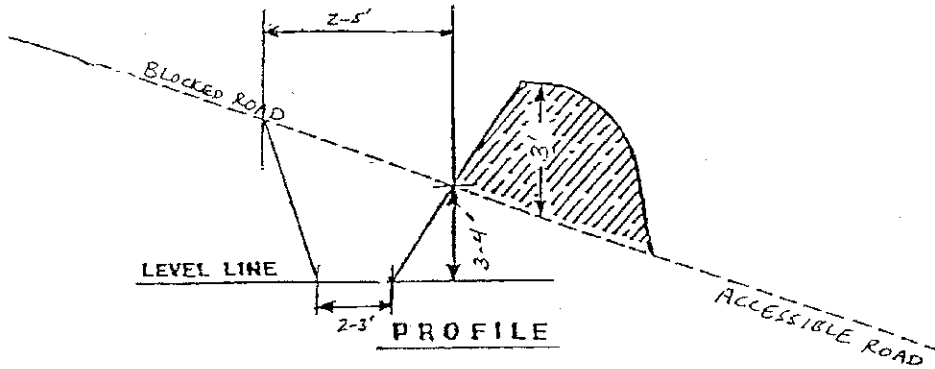
ROAD GRADE	DISTANCE
≤ 5%	600'
6-10%	300'
11-15%	150'
16-20% or greater	100'



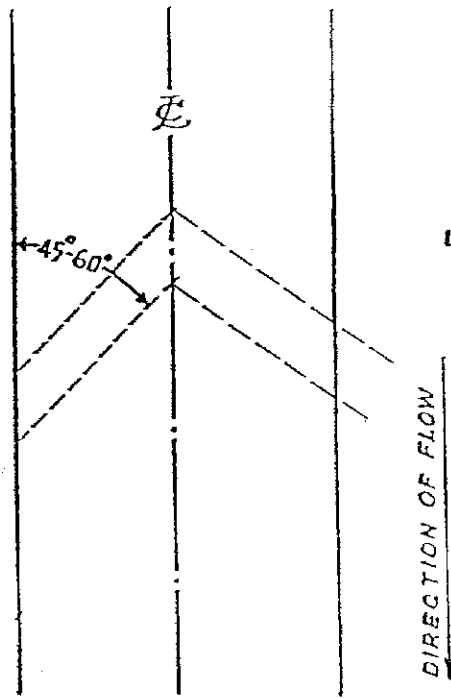
**WATERBAR SPECIFICATIONS  
 FOR CROSS DITCHING #298**

EXHIBIT L

TANK TRAP SPECIFICATIONS



Tank trap shall be installed in a "V" shape. It should be sloped to drain with a relief ditch through the down slope edge of the road. The trench shall be behind the berm for approaching traffic.



PLAN VIEW

TANK TRAP SPECIFICATIONS

EXHIBIT M

SPECIFICATIONS FOR LANDING SLASH PILING

Piling Slash/Covering Piles: All piles shall be as compact as possible. Piles shall be built to a minimum height of 3 to 4 feet and then covered to prevent water from reaching the Slash. PURCHASER shall supply the materials for covering. Additional woody debris shall be piled on top of the covered piles to complete the piling, as directed by STATE.

Placement of Piles: Piles shall be placed in a location to minimize damage from burning to standing green trees and Snags. Piles shall be placed as follows:

- (a) No less than 30 feet from any Snags or green trees, unless otherwise approved by STATE.
- (b) Cull log segments suitable for firewood shall be piled separately from Slash at a distance of no closer than 20 feet from the Slash piles.

State Timber Sale Contract  
No. 341-11-79  
Jack Flash

## EXHIBIT N

### SPECIFICATIONS FOR ROAD VACATING

Remove fill material from stream channels. Reestablish the original stream channel grade and orientation. Excavate channel banks to 1½:1 side slopes and place and compact excavated material in a stable location at a slope no greater than 1½:1. Divert all live water around construction site. Notify STATE 24 hours prior to removal of fills.

Construct water bars so that water is carried across the road and deposited on stable locations. Waterbars shall be angled across the road, deep enough to intercept water from any road ditchline and carry it across the road, and spaced as shown in Exhibit K.

Deliver removed culverts to the Tillamook District, 5005 3<sup>rd</sup> Street, Tillamook Oregon.

PURCHASER shall close roads by constructing a tank trap as specified in Exhibit I at the beginning of such roads. The barrier shall make the road impassable to vehicular traffic.

Grass seed all closed road surfaces, including all turnouts, landings, and turnarounds, along with all disturbed soil along these roads, according to the specifications in Exhibit O.

Mulch all removed fill material and areas of disturbed soil after grass seeding, according to the specifications in Exhibit J.

## PART IV: OTHER INFORMATION

State Timber Sale Contract  
No. 341-11-79  
Jack Flash



### WRITTEN PLAN

**SALE NAME:** Jack Flash, 341-11-79

**PROTECTED WATERS:** Ben Smith Creek, large Type F Stream, Un-named tributary to Ben Smith Creek, large Type F Stream.

**Definitions:** Stream buffer: at least 100 feet horizontal distance from the high water mark on each side of the stream.

**LOCATION:** Portions of Sections 10, 11, 12, and 13, T1N, R7W, W.M., Tillamook County, Oregon.

**Activity:** Cable lines across stream.

**Protection measures:**

- All trees in the RMA are reserved from cutting.
- Cable yarding lines will be pulled out of the RMA prior to rigging the next yarding road.
- If trees or logs fall or slide into a stream channel they will be not be limbed, bucked, or removed without prior approval from ODF.
- Cable lines will be an average of at least 150 feet apart where they extend over or through the Type F stream and buffer.

**Date:** February 1, 2011

**Prepared by:** David Wells

**NOTICE OF TRANSFER OF STATE TIMBER**

**Instructions:**

**629:-Form-301-010**

Complete Section 1. Mark the box which applies to you/your company in Section 2. Complete Section 3 and obtain signatures.

**SECTION 1**

On \_\_\_\_\_, state timber sale purchaser (Transferor)  
\_\_\_\_\_, sold, exchanged or otherwise transferred to  
\_\_\_\_\_, (Transferee) state timber originating from State  
Timber Sale Contract No. \_\_\_\_\_.

Transferee hereby certifies that they:

- (a) Will not export the unprocessed state timber which is the subject of this transaction;
- (b) Will not sell, transfer, exchange or otherwise convey the unprocessed timber which is the subject of this transaction to any other person without first obtaining a like certification from that person.
- (c) Are not prohibited by OAR's 629-31-005 through 045 from purchasing state timber or logs directly from the State Forester, or this is a sale of Western Red Cedar for domestic processing.

**SECTION 2**

- Have not exported unprocessed timber originating from private lands in Oregon in the last 24 months.
- This is a sale of hardwood logs for domestic processing.
- This is a sale of Western Red Cedar for domestic processing.
- This is a sale of pulp logs or cull logs processed at domestic pulp mills, domestic chip plants or other domestic operations for the purpose of conversion of the logs into chips.

**SECTION 3**

The parties understand that falsely entering into this certification, or failure to comply with the terms of this certification is a violation of the Forest Conservation and Shortage Relief Act of 1990 and OAR Chapter 629, Division 31, and is subject to any and all penalties contained therein.

Transferor:

Transferee:

Signed \_\_\_\_\_

Signed \_\_\_\_\_

Title \_\_\_\_\_

Title \_\_\_\_\_

Dated \_\_\_\_\_

Dated \_\_\_\_\_

[Note: For the purpose of this form, the definition of unprocessed timber is the same as in OAR 629-31-005].

Mail To: State Forester  
2600 State Street  
Salem, OR 97310