

PART III: EXHIBITS

State Timber Sale Contract
No. 341-10-92
Waterhouse

EXHIBIT B

Page 1 of 3
629-Form 341-203
Revised 06/97

OREGON DEPARTMENT OF FORESTRY

TIMBER SALE OPERATIONS PLAN

(See Page 2 for instructions)

Date Received by STATE: _____

(5) State Brand Information (complete):



(1) Contract No.: 341-10-92

(2) Sale Name: Waterhouse

(3) Contract Expiration Date: June 30, 2012

Project Completion Dates: _____

(4) Purchaser: _____

(6) Purchaser Representatives:

Projects: _____

Phone: _____

Cell/Other

Phone: _____

Home: _____

Projects: _____

Phone: _____

Cell/Other

Phone: _____

Home: _____

Projects: _____

Phone: _____

Cell/Other

Phone: _____

Home: _____

Projects: _____

Phone: _____

Cell/Other

Phone: _____

Home: _____

Logging: _____

Phone: _____

Cell/Other

Phone: _____

Home: _____

Logging: _____

Phone: _____

Cell/Other

Phone: _____

Home: _____

Logging: _____

Phone: _____

Cell/Other

Phone: _____

Home: _____

Logging: _____

Phone: _____

Cell/Other

Phone: _____

Home: _____

(7) State Representatives:

Projects: _____

Phone: _____

Cell/Other

Phone: _____

Home: _____

Logging: _____

Phone: _____

Cell/Other

Phone: _____

Home: _____

(8) Name of Subcontractors & Starting Dates:

Projects: No(s) _____ - _____

Date: _____

Phone: _____

No(s) _____ - _____

Date: _____

Phone: _____

No(s) _____ - _____

Date: _____

Phone: _____

No(s) _____ - _____

Date: _____

Phone: _____

Logging: Felling _____

Date: _____

Phone: _____

Yarding: _____

Date: _____

Phone: _____

(9) Comments:

(10) Operations Map: Attach a copy of timber sale Exhibit A or other suitable map which plainly shows the items listed on the instruction sheet.

EXHIBIT B
OPERATIONS PLAN
INSTRUCTION SHEET FOR OPERATIONS PLAN

SUBMIT ONE COPY OF PLAN TO STATE







Operations shall be limited to the work shown in the plan until a revised plan or supplemental plan is submitted covering additional work. Compliance with this plan is not in lieu of compliance with any federal requirements related to the federal Endangered Species Act. If STATE has prepared a required Forest Practices Act (FPA) "Written Plan" for operations, PURCHASER shall comply with all provisions of the Written Plan.

Item No. (from Page 1)

- (5) All sales require you to use a brand furnished by STATE. If the State brand has not been assigned when the plan is submitted, it will be furnished and assigned later. Complete drawing. If more than one brand is assigned to the sale, complete both drawings.
- (6) The contract requires you to have a designated representative available on the sale area or work location who is authorized to receive in your behalf any notice or instruction given by STATE and to take action in regard to performance under the contract. If logging and project work is widely separated, a representative is required for each.
- (7) The STATE representative will be designated when your plan is approved and is the person who will inspect and issue instructions regarding performance.
- (8) Show names of subcontractors to be used for any or all phases of the operations. If subcontractors are not known, or are changed later, give notification to the STATE representative prior to commencement of work by subcontractor.

Show projected dates for commencement of both projects and logging. If projected dates need to be changed at a later date, notification must be given to the STATE representative by supplemental plan or otherwise, prior to commencement of such operations.

- (10) The STATE representative will furnish extra copies of Exhibit "A" of the contract for your use in preparing the operations map. The map shall use the following legend and show:
 - 1. Landing locations, approximate setting boundaries, and probable sequence of logging the settings. Number the settings in sequence.
 - 2. Locations of spur roads planned for construction, other than those required by the timber sale contract. Provide spur road specifications.
 - 3. Location of proposed tractor yarding roads. Show if and how marked on the ground.
 - 4. Location of temporary stream crossings.
 - 5. List the sequence of performing project work.
 - 6. Location of rock sources - attach pit development plans.

-  Cable landing, with numbers for sequence.
-  Tractor landing with alphabetical sequence.
-  Approximate setting boundary.
-  Spur truck roads.
-  Tractor yarding roads.
-  Temporary stream crossings.

Original: Salem
cc: District File
Purchaser

EXHIBIT B
OPERATIONS PLAN

Completion Timeline

Indicate on the appropriate timeline below, the dates by which you plan to complete the work as required under this contract. The purpose of this section is to develop a plan that will ensure you complete the work as required, and meet the interim completion date(s) and contract expiration date. This plan is incorporated and made a part of the contract. When, in the opinion of STATE, operations are not commencing in a manner that meets the intent of this plan, you may be placed in violation of contract and your operations suspended until an amended plan is submitted and approved by STATE.

Projects

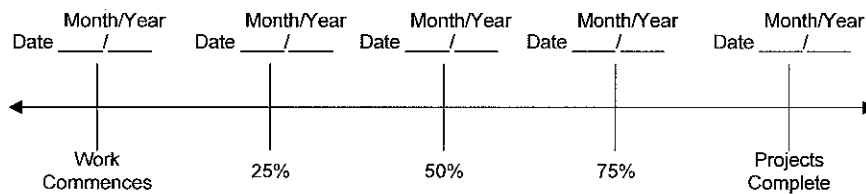

Harvest & Other Requirements

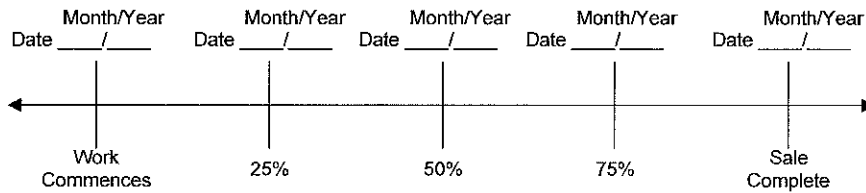

The Federal Endangered Species Act (ESA) prohibits a person from taking any federally listed threatened or endangered species. Taking under the federal ESA may include alteration of habitat. The STATE's approval of this plan does not certify that the PURCHASER's operation under the plan is lawful under the federal ESA. As provided in the timber sale contract, PURCHASER's must comply with all applicable state, federal, and local laws.

PURCHASER's compliance with this plan is not in lieu of compliance with any federal requirements related to the federal Endangered Species Act.

APPROVED: Date: _____

SUBMITTED BY:
PURCHASER

STATE OF OREGON - DEPARTMENT OF FORESTRY

Title _____

Title _____

Original: Salem
cc: District File
Purchaser

EXHIBIT C - SAWLOG

SCALING INSTRUCTIONS -- LOCATION APPROVAL -- BRAND INFORMATION

- (1) ORIGINAL REGISTRATION Date _____
 REVISION NUMBER _____ Date _____
 CANCELLATION Date _____
- (2) TO: _____
 (Third Party Scaling Organization)
- (3) FROM: Tillamook (06) Phone (503)842-2545
 (State Forestry District)
 Address 5005 3rd St., Tillamook, OR 97141
- (4) PURCHASER: _____
 Mailing Address: _____
 Phone Number: _____

- (12) NOTICE OF CANCELLATION OF BRAND:
 Effective Date: _____
 State Forester's Representative _____
- (13) SALE NAME Waterhouse
 COUNTY Tillamook
- (14) STATE CONTRACT NUMBER 341-10-92
- (15) STATE BRAND REGISTRATION NUMBER _____
- (16) STATE BRAND INFORMATION:
 (COMPLETE)

MINIMUM SCALING SPECIFICATIONS			CLASS		
SPECIES	SCALING DIAMETER INCHES	*NET SCALE VOLUME	PER MBF	** SUM	SUB
Conifer	--	10	X		
Hardwoods	--	10	X		



- (17) PAINT REQUIRED: YES
 COLOR Orange

* Apply minimum volume test to whole logs over 40' Westside; 20' Eastside.
 ** Sum (if indicated): see instructions and explain in Item (19).

- (6) WESTSIDE SCALE: YES NO
 Use Region 6 actual taper rule. Logs over 40'.
- (7) EASTSIDE SCALE: YES NO
 Use Region 6 actual taper rule. Logs over 40'.
- (8) Weight Scale Sample YES NO
 (6) - (8), pink log load receipts
- (9) Weight Sale YES NO
- (10) Per Load YES NO
 (9) and (10), yellow log load receipts

(18) SPECIAL REQUESTS
PEELABLE CULL (all species)
NO DEDUCTIONS ALLOWED FOR MECHANICAL DAMAGE
ADD-BACK VOLUME - Deductions due to delay
OTHER: _____

- (19) REMARKS: _____

Operator's Name (Optional inclusion by District): _____

- (20) SIGNATURES:

 Purchaser or Authorized Representative Date

 State Forester Representative Date

(11) APPROVED SCALING LOCATIONS	Species	Yard	Truck	Weight

Notify the District within one hour when branding or painting is inadequate for quick identification, the receipts are missing, not correctly or completely filled out, and/or when logs presented for scaling are impossible to scale accurately.

Distribution: ORIGINAL: Salem / COPIES: TPSO, Approved Scaling Location, Purchaser, District, Mgmt. Unit

EXHIBIT C

INSTRUCTIONS FOR FORM 343-307 (rev. 10/08)

- (1) Check appropriate box. REVISION NUMBER requires comments. CANCELLATION requires Item (12). Complete date.
- (2) Designate Third Party Scaling Organization (TPSO).
- (3) State District office, address and phone.
- (4) Enter Purchaser's business name, address, and phone number as it appears on the Contract.
- (5) Minimum Scaling Specifications. Review Section 2040 or 2045, "Log Removal," of the Contract. Species, or combined species can be separate entries. Information serves as a basis for scaling (see also Items (16) thru (18)), and is required to show existence on the sale. **SUM** (lump sum material). **SUB** (submerchantable material). SUB, as used by the State, references that material containing at least 10 bf (net) but less than the lower merchantable net volume limit or grade requirements for other merchantable (Per MBF) entries. Per MBF, SUM, and SUB must be indicated by checking the appropriate column. Species with the same specifications and value are combined into one entry. Per MBF and SUB require scaling therefore complete specifications. SUM need not be scaled, hence no specifications. Loads containing only SUM are to be ticketed if so instructed in Item (19). Mixed loads of SUM, Per MBF and/or subspecies will always be scaled.
- (6) Westside – Region 6 actual taper segment scale. Check Yes or No. Special Service Rules on file with TPSO. See: Segment Scaling and Grading of Long Logs -- All Species -- State Forestry Department Scaling Practices (Westside).
- (7) Eastside – Region 6 actual taper/taper table segment scale. Special Service Rules on file with TPSO. See: Segment Scaling and Grading of Long Logs -- All Species -- State Forestry Department Scaling Practices (Northwest Log Rules Eastside). Items with * follow U.S. Forest Service Eastside rules.
- (8) Weight Scale Sample – Check box if sale is to be a Weight Scale Sample. All specifics for handling, scaling and processing will be attached or explained in the Remarks section Item (19).
- (9) Weight Sale – Check box if sale is to be sold as a weight sale. Processing procedures from approved locations to TPSO's will be explained in the Remarks section of Item (19).
- (10) Per Load – Check box if volumes on sale are per load. Specific instructions for handling and processing will be fully explained in the Remarks section of Item (19).
- (11) Show scaling locations only applicable to TPSO. Location name should appear as it does on the ODF Approved Scaling Location web site: http://www.odf.state.or.us/DIVISIONS/management/asset_management/ScalingLocation.asp Locations with scaling and processing directions specific to their location should be on a separate form. Species should be identified if not capable of receiving "all" species. Check appropriate box for either: yard, truck scale, or weight. Refer to the web site listed above for the locations approval status.
- (12) When logging and hauling is complete, recall branding hammers, date and sign where indicated, check CANCELLATION box in Item (1), and send to TPSO.
- (13) Enter sale name and county
- (14) Enter sale Contract number.
- (15) Enter Oregon's State Brand Registry Number (required).
- (16) Show brand assigned to timber sale. One brand only. If more than one brand is assigned to the sale: (1) make separate form for each brand and (2) on each form, explain and show other brand(s) in the Remarks section Item (19).
- (17) Check yes for Paint Required and designate "Orange" for color. Non required removal volumes may sometimes require blue paint.
- (18) Special Requests. These are requests that will be applied to ODF timber sales. If "Other" is indicated, it must contain a description and any necessary comments.
- (19) Use this space to designate any weight conversion factors, per load volumes, weight scale sample instructions or any other explanations to clarify scaling or processing requirements. If additional scaling locations are approved, prepare another form showing all (old and new) locations. Check REVISION box at top of form and explain under remarks. Route as indicated.
- (20) Require purchaser to sign and date completed form.

EXHIBIT C – PULP SORT

SCALING INSTRUCTIONS -- LOCATION APPROVAL -- BRAND INFORMATION

- (1) ORIGINAL REGISTRATION Date _____
 REVISION NUMBER _____ Date _____
 CANCELLATION Date _____

(2) TO: _____
 (Third Party Scaling Organization)

(3) FROM: Tillamook (06) Phone (503) 842-2545
 (State Forestry District)
 Address 5005 3rd St., Tillamook, OR 97141

(4) PURCHASER: _____
 Mailing Address: _____
 Phone Number: _____

(5) MINIMUM SCALING SPECIFICATIONS			CLASS		
SPECIES	SCALING DIAMETER INCHES	*NET SCALE VOLUME	PER MBF	** SUM	SUB
Pulp	By weight				

* Apply minimum volume test to whole logs over 40' Westside; 20' Eastside.
 ** Sum (if indicated): see instructions and explain in Item (19).

- (6) WESTSIDE SCALE: YES NO
 Use Region 6 actual taper rule. Logs over 40'.
 (7) EASTSIDE SCALE: YES NO
 Use Region 6 actual taper rule. Logs over 40'.
 (8) Weight Scale Sample YES NO
 (6) – (8), pink log load receipts
 (9) Weight Sale YES NO
 (10) Per Load YES NO
 (9) and (10), yellow log load receipts

(11) APPROVED SCALING LOCATIONS	Species	Yard	Truck	Weight

(12) NOTICE OF CANCELLATION OF BRAND:
 Effective Date: _____

State Forester's Representative

(13) SALE NAME Waterhouse

COUNTY Tillamook

(14) STATE CONTRACT NUMBER 341-10-92

(15) STATE BRAND REGISTRATION NUMBER _____

(16) STATE BRAND INFORMATION:

(COMPLETE) ↓



(17) PAINT REQUIRED: YES
 COLOR Blue

(18) SPECIAL REQUESTS
PEELABLE CULL (all species) NO DEDUCTIONS ALLOWED FOR MECHANICAL DAMAGE ADD-BACK VOLUME - Deductions due to delay
OTHER: Convert weight to MBF, using a factor of 10 tons per MBF.

(19) REMARKS Pulp logs shall be weighed in lieu of scaling. Tons shall be short tons or 2,000 lbs. (1) Weigher will attach a machine printed weight ticket to the scaler receipt part of the STATE Log Load Receipt and mail them weekly to the approved Third Party Scaling Organization (TPSO). (2) The TPSO shall notify the Tillamook District office immediately if the above requirements are not met.

Operator's Name (Optional inclusion by District): _____

(20) SIGNATURES:

 Purchaser or Authorized Representative Date

 State Forester Representative Date

Notify the District within one hour when branding or painting is inadequate for quick identification, the receipts are missing, not correctly or completely filled out, and/or when logs presented for scaling are impossible to scale accurately.

Distribution: ORIGINAL: Salem / COPIES: TPSO, Approved Scaling Location, Purchaser, District, Mgmt. Unit

EXHIBIT C

INSTRUCTIONS FOR FORM 343-307 (rev. 10/08)

- (1) Check appropriate box. REVISION NUMBER requires comments. CANCELLATION requires Item (12). Complete date.
- (2) Designate Third Party Scaling Organization (TPSO).
- (3) State District office, address and phone.
- (5) Enter Purchaser's business name, address, and phone number as it appears on the Contract.
- (5) Minimum Scaling Specifications. Review Section 2040 or 2045, "Log Removal," of the Contract. Species, or combined species can be separate entries. Information serves as a basis for scaling (see also Items (16) thru (18)), and is required to show existence on the sale. **SUM** (lump sum material). **SUB** (submerchantable material). **SUB**, as used by the State, references that material containing at least 10 bf (net) but less than the lower merchantable net volume limit or grade requirements for other merchantable (Per MBF) entries. Per MBF, SUM, and SUB must be indicated by checking the appropriate column. Species with the same specifications and value are combined into one entry. Per MBF and SUB require scaling therefore complete specifications. SUM need not be scaled, hence no specifications. Loads containing only SUM are to be ticketed if so instructed in Item (19). Mixed loads of SUM, Per MBF and/or subspecies will always be scaled.
- (6) Westside -- Region 6 actual taper segment scale. Check Yes or No. Special Service Rules on file with TPSO. See: Segment Scaling and Grading of Long Logs -- All Species -- State Forestry Department Scaling Practices (Westside).
- (7) Eastside -- Region 6 actual taper/taper table segment scale. Special Service Rules on file with TPSO. See: Segment Scaling and Grading of Long Logs -- All Species -- State Forestry Department Scaling Practices (Northwest Log Rules Eastside). Items with * follow U.S. Forest Service Eastside rules.
- (8) Weight Scale Sample -- Check box if sale is to be a Weight Scale Sample. All specifics for handling, scaling and processing will be attached or explained in the Remarks section Item (19).
- (9) Weight Sale -- Check box if sale is to be sold as a weight sale. Processing procedures from approved locations to TPSO's will be explained in the Remarks section of Item (19).
- (10) Per Load -- Check box if volumes on sale are per load. Specific instructions for handling and processing will be fully explained in the Remarks section of Item (19).
- (11) Show scaling locations only applicable to TPSO. Location name should appear as it does on the ODF Approved Scaling Location web site: http://www.odf.state.or.us/DIVISIONS/management/asset_management/ScalingLocation.asp Locations with scaling and processing directions specific to their location should be on a separate form. Species should be identified if not capable of receiving "all" species. Check appropriate box for either: yard, truck scale, or weight. Refer to the web site listed above for the locations approval status.
- (12) When logging and hauling is complete, recall branding hammers, date and sign where indicated, check CANCELLATION box in Item (1), and send to TPSO.
- (13) Enter sale name and county
- (14) Enter sale Contract number.
- (15) Enter Oregon's State Brand Registry Number (required).
- (16) Show brand assigned to timber sale. One brand only. If more than one brand is assigned to the sale: (1) make separate form for each brand and (2) on each form, explain and show other brand(s) in the Remarks section Item (19).
- (17) Check yes for Paint Required and designate "Orange" for color. Non required removal volumes may sometimes require blue paint.
- (18) Special Requests. These are requests that will be applied to ODF timber sales. If "Other" is indicated, it must contain a description and any necessary comments.
- (19) Use this space to designate any weight conversion factors, per load volumes, weight scale sample instructions or any other explanations to clarify scaling or processing requirements. If additional scaling locations are approved, prepare another form showing all (old and new) locations. Check REVISION box at top of form and explain under remarks. Route as indicated.
- (20) Require purchaser to sign and date completed form.

EXHIBIT D
FOREST ROAD SPECIFICATIONS

SUBGRADE WIDTH	SURFACED WIDTH	POINT TO POINT	STATION TO STATION	DRAINAGE
15 feet	12 feet	A to B	0+00 to 8+00	Outslope
15 feet	12 feet	C to D	0+00 to 23+50	Outslope
As-Is	12 feet	E to F	0+00 to 14+00	As-Is
As-Is	As-Is	G to H	0+00 to 159+00	As-Is

CLEARING. A to B and C to D Only

This work shall consist of clearing, removing, and disposing of all trees, Snags, Down Timber, brush, surface objects, and protruding obstructions within the clearing limits.

Where clearing limits have not been marked, the clearing limits shall extend 10 feet back of the top of the cutslope and 5 feet out from the toe of the fill slope, or as directed by STATE. Clearing debris shall not be placed or permitted to remain in or under any road embankment sections. Clearing debris shall not be left lodged against standing trees.

All danger trees, leaners, and Snags outside the clearing limits which could fall and hit the road shall be felled.

GRUBBING. This work shall consist of the removal or digging out of stumps and protruding objects.

All stumps shall be completely removed within the limits of required grubbing. Stumps overhanging cutslopes shall be removed. Grubbing debris shall not be placed or permitted to remain in or under any road embankment sections. Grubbing debris shall not be left lodged against standing trees. Grubbing classifications are as follows:

New construction - From the top of the cutslope to the toe of the fill.

Trees outside the clearing limits shall not be felled unless approved in writing by STATE.

CLEARING AND GRUBBING DISPOSAL. Scatter through openings in the timber outside of the cleared right-of-way, except areas where end-haul is required or in any stream channel (Type F, N or D) or where material may enter the stream channel.

EXHIBIT D

FOREST ROAD SPECIFICATIONS

EXCAVATION. Excavation and grading shall not be done when weather and/or ground conditions are such that damage will result to existing subgrade or cause excessive erosion.

Excavation shall conform to STATE-engineered lines, grades, dimensions, and plans when provided.

All suitable excavated material shall be used where possible for the formation of fills, shoulders, and drainage structure backfills. Embankment materials shall be free of woody debris, brush, muck, sod, frozen material, and other deleterious materials. All fills and drainage structure backfills shall be machine compacted according to the specifications in Exhibit E.

Unless road design plans show otherwise, all roads shall be on a balanced cross section, except when the slope is over 60 percent, the road shall be on full bench for the width specified.

Excess excavation shall not be sidecast where material will enter a stream course or where material will accumulate in areas deemed a high landslide hazard location by STATE.

Bank excavation on a project road segment shall be completed prior to subgrade approval.

ROAD WIDTH LIMITATIONS. PURCHASER shall obtain advance written approval from STATE to construct the road to a greater width than specified. Extra subgrade width shall be required for:

Fill Widening. Add to each fill shoulder 1 foot for fills 3 feet to 6 feet high; 2 feet for fills over 6 feet high.

Curve Widening. Widen the inside shoulder of all curves as follows: 400 divided by the radius of the curve equals the amount of extra width.

DRAINAGE

Outslope. Road subgrade shall be outsloped at 4 to 6 percent.

As-Is. No change in drainage configuration.

TURNOUTS. Increase roadbed width an additional 8 feet for both subgrade and surfacing. Length shall be at least 25 feet, or as staked on the ground, plus 25-foot approaches at each end.

Location: Intervisible but not greater than 750 feet.

GRADING

Back Slopes

Fill Slopes

Rock
Common -

Vertical to 1/4:1
3/4:1

Not steeper
than 1 1/2:1

Top of outslope shall be rounded.

LANDINGS. Landings shall be constructed as posted in the field, no less than 50 feet wide and no more than 70 feet wide. Surface shall be crowned for drainage.

TURNAROUNDS. Increase subgrade width an additional 30 feet for a length of 16 feet with 20' radius returns at locations marked in the field.

EXHIBIT E
 ROAD SURFACING

ROAD SEGMENT: A to B			STATIONS: 0+00 to 8+00					
Application	Rock Size and Type	Location	Compacted Depth	Volume (CY) per		Number of Units	Curve Widening (CY)	Approx. Total (CY)
Road Rock	Crushed 4"-0"	0+00 to 8+00	9 "	station	48	8.00	20	404
Turnouts	Crushed 4"-0"	A to B	9 "	TO	20	1		20
Turnarounds	Crushed 4"-0"	2+00	9 "	TA	30	1		30
Application	Rock Size and Type	Location	Approx. Total (CY)					
Landing Rock	Crushed 4"-0"	6+00	100					
ROAD SEGMENT: C to D			STATIONS: 0+00 to 23+50					
Application	Rock Size and Type	Location	Compacted Depth	Volume (CY) per		Number of Units	Curve Widening (CY)	Approx. Total (CY)
Road Rock	Crushed 4"-0"	0+00 to 23+50	9 "	station	48	23.50	60	1,188
Turnouts	Crushed 4"-0"	C to D	9 "	TO	20	4		80
Turnarounds	Crushed 4"-0"	21+00	9 "	TA	30	1		30
Application	Rock Size and Type	Location	Approx. Total (CY)					
Landing Rock	Crushed 4"-0"	23+50	100					
ROAD SEGMENT: E to F			STATIONS: 0+00 to 14+00					
Application	Rock Size and Type	Location	Compacted Depth	Volume (CY) per		Number of Units	Curve Widening (CY)	Approx. Total (CY)
Road Rock	Crushed 1 1/2"-0"	0+00 to 14+00	3 "	station	15	14.00	10	220
ROAD SEGMENT: G to H			STATIONS: Private Ownership					
Spot Rock	Crushed 1 1/2"-0"	*	200					

*As Marked In Field

Roads shall be uniformly graded and approved by STATE prior to rocking.

Additional rock for curve widening is required and has been included in the volume estimates.

Turnouts, turnarounds, landings shall be rocked concurrently with the road.

Any additional turnarounds or turnouts created during any operation associated with this timber sale shall be rocked at PURCHASER's expense and as instructed by STATE.

Roads shall be uniformly graded and approved by STATE prior to rocking. For typical cross section, turnout and turnaround see Forestry Department Drawing Nos. 351-C, 351-D and TOTA-1 at the Forestry Department district office.

EXHIBIT E

ROCK ACCOUNTABILITY

PURCHASER shall obtain STATE approval for subgrades prior to rocking. Rocking must be done only when weather conditions are acceptable to STATE, and must be suspended when muddy water could enter streams.

Rock accountability shall be determined by depth measurement. STATE shall be given 24 hours' notice prior to rocking.

Depth Measurement. Road rock shall be spread and compacted according to the depths specified in Exhibit E. Truck measure volumes are given, but shall not limit the amount of rock spread.

Depth shall be determined in the most compacted area of the surface cross section. If additional rock is required because of insufficient depth, it shall be added by truck measure to those areas that were slighted. The conversion from compacted yardage to truck yardage is 1.3 multiplied by the compacted yardage equals truck yardage.

The depth of compacted aggregates shall not vary more than 1 inch from the depth specified in Exhibit E. The average depth for each road segment shall be the specified depth or greater.

Turnouts shall have a surfaced area of at least 44 square yards each at the depths shown in Exhibit E.

Turnarounds shall have a surfaced area of at least 73 square yards each at the depths shown in Exhibit E.

Landings shall have a minimum surfaced area of at least 314 square yards each at the depths shown in Exhibit E.

Curve Surfacing. Extra surface width shall be required for the inside of all curves as follows: 400 divided by the radius of the curve equals the amount of extra width to be surfaced at the depths shown in Exhibit E.

EXHIBIT E

COMPACTION AND PROCESSING REQUIREMENTS

Subgrade. Subgrade surfaces of the road segments listed below shall be graded and compacted prior to rocking. Compaction shall be accomplished by traveling all surfaces from shoulder to shoulder until visible deformation ceases, or in the case of a sheepsfoot roller, the roller "walks out." At least 3 passes shall be made over the entire width and length of the road. A pass is defined as traveling a road section in one direction and then back over that same section again. Compaction shall be accomplished by using the approved equipment listed below or others approved by STATE.

ROAD SEGMENT	COMPACTION EQUIPMENT OPTIONS
A to B, C to D and E to F	Vibratory Roller

Fills. Embankments and fills shall be placed in (approximately) horizontal layers not more than 8 inches in depth. Each layer shall be separately, and thoroughly, compacted. Compaction equipment shall be operated over the entire width of each layer until visible deformation of the layers ceases or, in the case of a sheepsfoot roller, the roller "walks out." At least 3 passes shall be made over the entire width and length of each layer. A pass is defined as traveling a fill layer in one direction and then back over that same layer again.

Placing individual rocks or boulders with more depth than the allowed layer thickness shall be permitted, provided the embankment will accommodate them. Such rocks and boulders shall be at least 6 inches below the subgrade. They shall be carefully distributed and the voids filled with finer material, forming a dense and compacted mass. Compaction shall be accomplished by using the approved equipment listed below or others approved by STATE:

ROAD SEGMENT	COMPACTION EQUIPMENT OPTIONS
A to B and C to D	Crawler Tractor

Crushed Rock. The rock shall be uniformly mixed and spread in layers on the approved roadbed. Each layer of crushed rock shall be moistened or dried to a uniform moisture content suitable for maximum compaction and compacted in layers not to exceed 6 inches in depth. When more than 1 layer is required, each shall be shaped and compacted before the succeeding layer is placed. Any irregularities or depressions that develop during compaction of the top layer shall be corrected by loosening the material at these places and adding or removing material until the surface is smooth and uniform. Each layer shall be compacted with a minimum of 3 passes over the entire width and length of the road. A pass is defined as traveling a road section in one direction and then back over that same section again. Compaction shall be accomplished by using the approved equipment listed below or others approved by STATE:

Rock shall be compacted and processed during the same project period it is spread, unless otherwise approved in writing by STATE.

Rock shall be crowned at 4 to 6 percent unless otherwise specified.

ROAD SEGMENT	COMPACTION EQUIPMENT OPTIONS
A to B, C to D and E to F	Vibratory Roller

EXHIBIT E

COMPACTION EQUIPMENT OPTIONS

Vibratory Rollers. The drum shall have a smooth surface, a diameter not less than 48 inches, a width not less than 58 inches, and a turning radius of 15 feet or less. Vibration frequency shall be regulated in steps to 1400, 1500, and 1600 VPM, corresponding to engine speeds of 1575, 1690, and 1800 RPM. The centrifugal force developed shall be 7 tons at 1600 VPM. It shall be activated by a power unit of not less than 25 horsepower. The vibratory roller shall be self-propelled and operated at speeds ranging from 0.9 miles to 1.8 miles per hour, as directed by STATE.

Crawler Tractors. D-7 Caterpillar or equivalent or larger.

EXHIBIT F

CULVERT SPECIFICATIONS

All culvert materials shall be furnished and installed by PURCHASER, unless otherwise specified in the Contract. Culverts shall be constructed of corrugated polyethylene. Culverts shall conform to the material and fabricating requirements of the "Standard Specifications for Highway Construction" prepared by the Highway Division of the Oregon State Department of Transportation. Polyethylene culverts shall also be double walled and meet the requirements of AASHTO M-294-901, Type S. Corrugation types and shapes other than those meeting the above minimum Highway requirements, shall be approved in writing by STATE.

Culverts shall be located according to the alignment and grade as shown on the Plan and Profile, and/or as staked in the field, or as stipulated in special instructions.

The STATE Representative shall determine final culvert locations and stake the locations in the field prior to installation.

Culvert grade shall slope away from ditch grade at least 5 percent unless otherwise specified.

The foundation and trench walls for all culverts shall be free from logs, stumps, limbs, stones, and other objects which would dent or damage the pipe. The culvert trench shall be excavated 3 pipe diameters wide to permit compaction and working on each side of the pipe. Tamping shall be done in 6-inch lifts, 1 pipe diameter each side of the pipe to 95 percent density or over. Bedrock shall be excavated as required to provide a uniform foundation for the full length of the culvert. Minimum bedding depth shall be 6 inches.

A bedding of granulated material or crushed rock as specified shall be placed to provide a wide band of support and to transmit the load from above evenly over the entire length of the pipe.

Backfill shall consist of granulated material, crushed rock, or job-excavated soil free of stumps, limbs, rocks, or other objects which would damage the pipe.

Transporting of the pipe shall be done carefully. Dragging or allowing free fall from trucks or into trenches shall not be permitted.

Joining shall be done with bands of like material and corrugations. Manufacturers' instructions shall be followed for prefabricated pipe assembly.

Polyethylene joints shall be made with split couplings, corrugated to engage the pipe corrugations, and shall engage a minimum of 4 corrugations, 2 on each side of the pipe joint.

When joints are employed, the longest length of pipe shall be placed at the outlet end.

A manufacturer's certification that the product was manufactured, tested, and supplied in accordance with this specification shall be furnished to the Project Engineer upon request.

Minimum height of cover over top of culvert to subgrade shall be as follows 12". Minimum vertical cover for other designs shall be as specified by STATE.

Lengths of individual culvert sections shall be not less than 10 feet, unless otherwise provided for in special instructions. The shortest culvert section length shall be placed at the inlet end.

EXHIBIT F
CULVERT LIST

CULVERT NO.	DIAMETER (Inches)	LENGTH (Feet)	ROAD SEGMENT POINT TO POINT	STATION
1	18	30	C to D	3+00
2	24	40	C to D	9+00

The intake end of culverts shall be marked by installing a 5 foot long, painted steel fence post two feet into the ground, within 6 inches of the inlet on the downgrade side.

Tamping is required on all culverts.

EXHIBIT G

FILL CONSTRUCTION SPECIFICATIONS

(no scale)

ALL TEMPORARY EARTH SLOPES SHALL COMPLY WITH OR-OSHA REQUIREMENTS. AREAS TO RECEIVE STRUCTURAL FILL THAT HAVE A SLOPE GREATER THAN 5 HORIZONTAL FEET TO 1 VERTICAL FOOT SHALL HAVE HORIZONTAL BENCHES AND KEYWAYS CUT INTO THE FILL AREAS PRIOR TO PLACING THE NEW FILLS. ALL FILL MATERIAL SHALL BE PLACED AS STRUCTURAL FILL BEYOND 1.5H:1V SLOPE AND THEN BE TRIMMED BACK TO A 1.5H:1V SLOPE SO THAT COMPACTED FILL IS EXPOSED ON THE FACE OF THE SLOPE (SEE DETAIL BELOW).

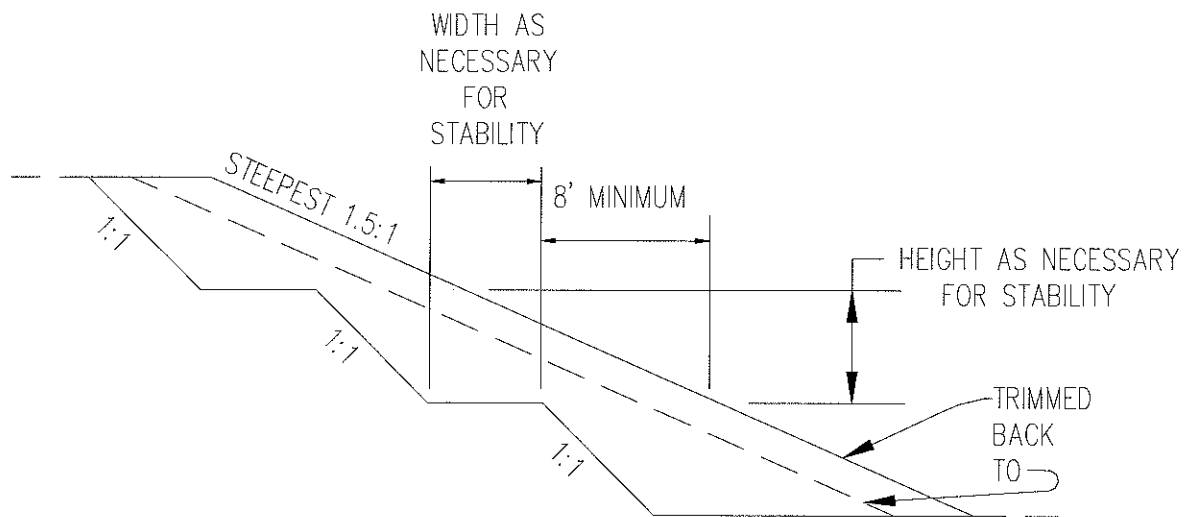

DETAIL: BENCHING AND SIDEHILL EMBANKMENT FILL CONSTRUCTION

THE STATE SHALL BE CONTACTED TO OBSERVE THE FINAL CUT AND FILL SLOPE CONFIGURATIONS AND CONDITIONS TO COMMENT ON THE NEED FOR FURTHER GRADING OR SLOPE STABILIZATION METHODS BASED ON THE FINAL GRADING CONDITIONS.

ONCE OBSERVED BY THE STATE, EROSION CONTROL MEASURES SHALL BE APPLIED TO THE GRADED SLOPES.

EXHIBIT H
 WATERBAR SPECIFICATIONS

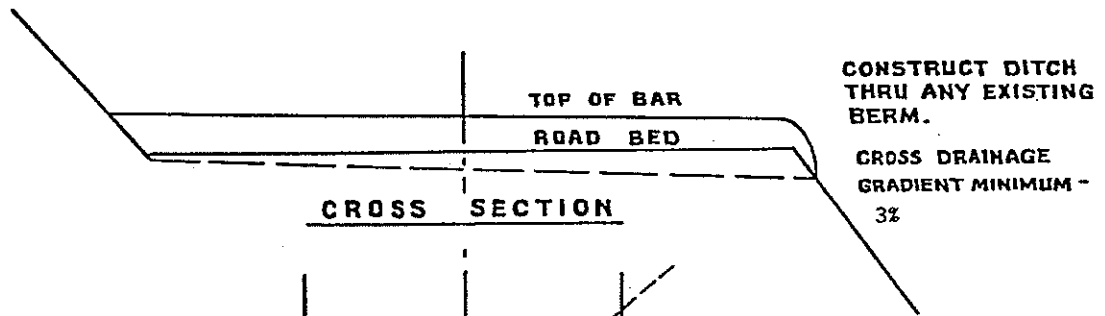
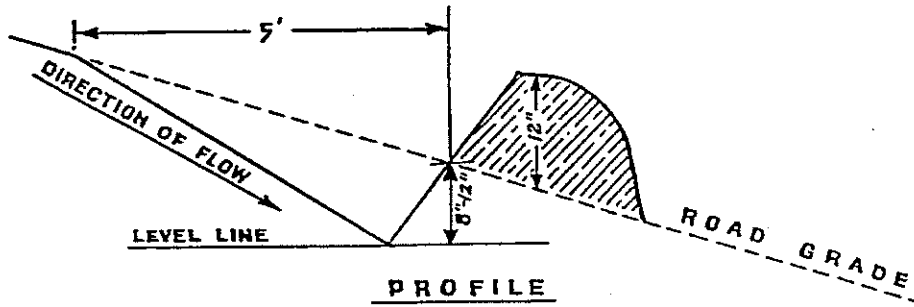

SPACING OF WATERBARS

ROAD GRADE	DISTANCE
≤ 5%	
6-10%	
11-15%	
16-20% or greater	

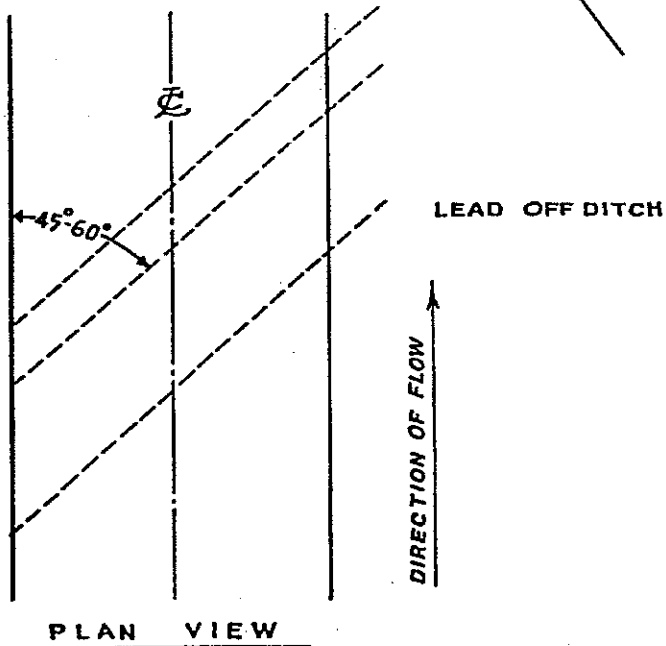

SPACING OF WATERBARS

ROAD GRADE	DISTANCE
≤ 5%	600'
6-10%	300'
11-15%	150'
16-20% or greater	100'

WATERBAR SPECIFICATIONS
 FOR CROSS DITCHING #298

EXHIBIT I

SEEDING AND FERTILIZING

This work shall consist of preparing seedbeds and furnishing and placing required seed and fertilizer.

Seeding Seasons. Seeding shall be performed only from March 1 through June 15 and August 15 through October 15. Seeding materials shall not be applied during windy weather or when the ground is excessively wet or frozen. Areas of disturbed soil shall be seeded by the end of the project period in which work was started. PURCHASER shall notify STATE 24 hours prior to seeding.

Soil Preparation. Areas to be seeded that have been damaged by erosion or other causes shall be restored prior to seeding. All areas to be seeded shall be finished and then cultivated to provide a reasonably firm, but friable seedbed. A minimum of 1/2 inch of surface soil shall be in a loose condition.

Application Methods for Seed and Fertilizer

Dry Method. Mechanical seeders, seed drills, landscape seeders, cultipacker seeders, fertilizer spreaders or other approved mechanical seeding equipment shall be used to apply the seed and fertilizer in the amounts and mixtures specified. Hand-operated seeding devices may be used when seed and fertilizer are applied in dry form.

Application Rates for Seed and Fertilizer

Seed listed below shall be applied at the following rates per acre:

<u>Species</u>	<u>Lb./Acre</u>	<u>Mixture</u>	<u>Pure Live Seed</u>	<u>Poison and/or Repellent</u>
Fine Fescue	12	40%	98%	0
Annual Ryegrass	6	20%	98%	0
Perennial Ryegrass	9	30%	98%	0
White Dutch Clover	3	10%	98%	0

Fertilizer: Chemical analysis shall be 16-20-0 and shall be applied at the rate of 300 pounds per acre.

Seeding will be considered acceptable when all other specified requirements in Exhibits I and J have been completed and a healthy, uniform, close stand of grass has been established, unless otherwise approved in writing by STATE.

EXHIBIT J
MULCHING

This work shall consist of furnishing and placing required mulch. Mulch shall consist of straw that is free of noxious weeds.

Mulching Period. Straw mulch shall be applied within 24 hours of spreading grass seed and fertilizer.

Application Rates for Mulch

Place straw mulch to a reasonably uniform thickness of $\frac{3}{4}$ to $1\frac{1}{4}$ inches. This rate requires between 1 and $1\frac{1}{2}$ tons of dry mulch per acre.

EXHIBIT K

FABRIC SPECIFICATIONS

FABRIC SPECIFICATIONS - shall be woven fabric designed for forest road subgrade surfacing purposes and shall meet or exceed the following requirements, unless otherwise approved in writing by STATE:

(1)	Grab Tensile	300 lbs.	ASTM D4632
(2)	Puncture Strength	110 lbs.	ASTM D4833
(3)	Mullen Burst	600 lbs./in	ASTM D3786
(4)	Width - 12.5 feet		

INSTALLATION REQUIREMENTS - fabric shall be installed according to the following requirements:

- (1) Typical cross section:

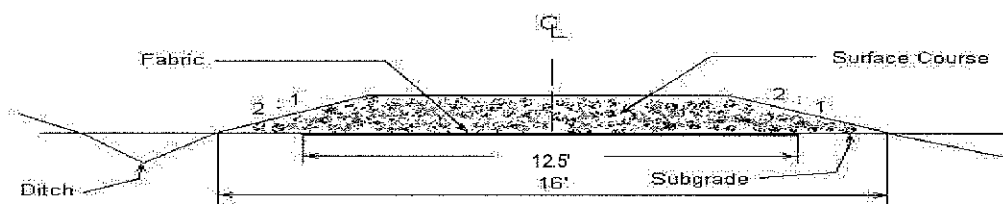

- (2) Subgrade surface shall be leveled and smoothed to remove humps and depressions which exceed 6 inches in height and depth. Small pieces of woody debris shall be removed or pushed below subgrade surface. Light vegetation (grass, weeds, leaves, and fine woody debris) may be left in place.
- (3) Fabric shall be installed directly on the prepared surface. Longitudinal and traverse joints shall be overlapped at least 3 feet.
- (4) Surfacing course material shall be placed to the designated thickness in one lift and spread in the direction of fabric overlap. Hauling and spreading equipment shall not be operated on the fabric until the total thickness of surfacing course material is placed.
- (5) Torn, punctured, or separated sections of the fabric shall be repaired by installing a fabric patch over the break prior to placing the surfacing course material. The patch shall be at least 4 feet larger in horizontal dimensions than the break to be repaired.

Fabric failures resulting after rock placement and as evidenced by subgrade pumping or roadbed distortion shall be corrected. Correction measures shall consist of: (1) removing at least three-quarters the depth of surfacing course material in the affected area, (2) placing a fabric patch over the affected area with a minimum 4-foot overlap around the circumference of the area, and (3) replacing enough rock to cover the patch and blend in with the rest of the road.

EXHIBIT L

SPECIFICATIONS FOR LANDING SLASH PILING

Piling Slash/Covering Piles: All piles shall be as compact as possible. Piles shall be built to a minimum height of 3 to 4 feet and then covered to prevent water from reaching the Slash. STATE shall supply the materials for covering. Additional woody debris shall be piled on top of the covered piles to complete the piling, as directed by STATE.

Placement of Piles: Piles shall be placed in a location to minimize damage from burning to standing green trees and Snags. Piles shall be placed as follows:

- (a) No less than 30 feet from any Snags or green trees, unless otherwise approved by STATE.
- (b) Cull log segments suitable for firewood shall be piled separately from Slash at a distance of no closer than 20 feet from the Slash piles.