

PART III: EXHIBITS

State Timber Sale Contract
No. 341-07-01
Trask Cutoff

EXHIBIT B

Page 1 of 3
629-Form 341-203
Revised 06/97

OREGON DEPARTMENT OF FORESTRY

TIMBER SALE OPERATIONS PLAN

(See Page 2 for instructions)



Date Received by STATE: _____

(5) State Brand Information (complete):

(1) Contract No.: 341-07-01

(2) Sale Name: Trask Cutoff

(3) Contract Expiration Date: June 30, 2009

Project Completion Dates: _____

(4) Purchaser: _____

(6) Purchaser Representatives:

Projects: _____	Phone: _____	Cell/Other Phone: _____	Home: _____
Projects: _____	Phone: _____	Cell/Other Phone: _____	Home: _____
Projects: _____	Phone: _____	Cell/Other Phone: _____	Home: _____
Projects: _____	Phone: _____	Cell/Other Phone: _____	Home: _____
Logging: _____	Phone: _____	Cell/Other Phone: _____	Home: _____
Logging: _____	Phone: _____	Cell/Other Phone: _____	Home: _____
Logging: _____	Phone: _____	Cell/Other Phone: _____	Home: _____
Logging: _____	Phone: _____	Cell/Other Phone: _____	Home: _____

(7) State Representatives:

Projects: _____	Phone: _____	Cell/Other Phone: _____	Home: _____
Logging: _____	Phone: _____	Cell/Other Phone: _____	Home: _____

(8) Name of Subcontractors & Starting Dates:

Projects: No(s) _____ - _____	Date: _____	Phone: _____
No(s) _____ - _____	Date: _____	Phone: _____
No(s) _____ - _____	Date: _____	Phone: _____
No(s) _____ - _____	Date: _____	Phone: _____
Logging: Felling _____	Date: _____	Phone: _____
Yarding: _____	Date: _____	Phone: _____

(9) Comments:

(10) Operations Map: Attach a copy of timber sale Exhibit A or other suitable map which plainly shows the items listed on the instruction sheet.

EXHIBIT B
INSTRUCTION SHEET FOR OPERATIONS PLAN

SUBMIT ONE COPY OF PLAN TO STATE

Operations shall be limited to the work shown in the plan until a revised plan or supplemental plan is submitted covering additional work. Compliance with this plan is not in lieu of compliance with any federal requirements related to the federal Endangered Species Act. If STATE has prepared a required Forest Practices Act (FPA) "Written Plan" for operations, PURCHASER shall comply with all provisions of the Written Plan.

Item No. (from Page 1)

- (5) All sales require you to use a brand furnished by STATE. If the State brand has not been assigned when the plan is submitted, it will be furnished and assigned later. Complete drawing. If more than one brand is assigned to the sale, complete both drawings.
- (6) The contract requires you to have a designated representative available on the sale area or work location who is authorized to receive in your behalf any notice or instruction given by STATE and to take action in regard to performance under the contract. If logging and project work is widely separated, a representative is required for each.
- (7) The STATE representative will be designated when your plan is approved and is the person who will inspect and issue instructions regarding performance.
- (8) Show names of subcontractors to be used for any or all phases of the operations. If subcontractors are not known, or are changed later, give notification to the STATE representative prior to commencement of work by subcontractor.

Show projected dates for commencement of both projects and logging. If projected dates need to be changed at a later date, notification must be given to the STATE representative by supplemental plan or otherwise, prior to commencement of such operations.

- (10) The STATE representative will furnish extra copies of Exhibit A of the contract for your use in preparing the operations map. The map shall use the following legend and show:
 1. Landing locations, approximate setting boundaries, and probable sequence of logging the settings. Number the settings in sequence.
 2. Locations of spur roads planned for construction, other than those required by the timber sale contract. Provide spur road specifications.
 3. Location of proposed tractor yarding roads. Show if and how marked on the ground.
 4. Location of temporary stream crossings.
 5. List the sequence of performing project work.
 6. Location of rock sources - attach pit development plans.



Cable landing, with numbers for sequence.



Tractor landing with alphabetical sequence.

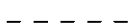

Approximate setting boundary.



Spur truck roads.

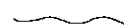

Tractor yarding roads.



Temporary stream crossings.

EXHIBIT B
OPERATIONS PLAN

Completion Timeline

Indicate on the appropriate timeline below, the dates by which you plan to complete the work as required under this contract. The purpose of this section is to develop a plan that will ensure you complete the work as required, and meet the interim completion date(s) and contract expiration date. This plan is incorporated and made a part of the contract. When, in the opinion of STATE, operations are not commencing in a manner that meets the intent of this plan, you may be placed in violation of contract and your operations suspended until an amended plan is submitted and approved by STATE.

Projects

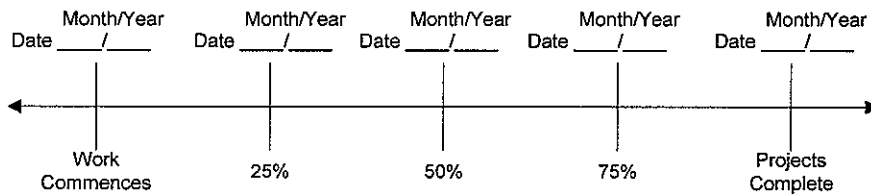

Harvest & Other Requirements

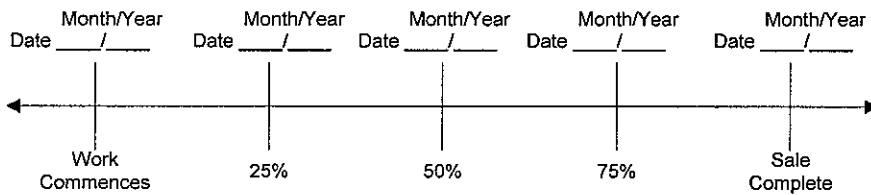

The Federal Endangered Species Act (ESA) prohibits a person from taking any federally listed threatened or endangered species. Taking under the federal ESA may include alteration of habitat. STATE's approval of this plan does not certify that PURCHASER's operation under the plan is lawful under the federal ESA. As provided in the timber sale contract, PURCHASERS must comply with all applicable state, federal, and local laws.

PURCHASER's compliance with this plan is not in lieu of compliance with any federal requirements related to the federal Endangered Species Act.

APPROVED: Date: _____

SUBMITTED BY:
PURCHASER

STATE OF OREGON - DEPARTMENT OF FORESTRY

Title _____

Title _____

Original: Salem
cc: District File
Purchaser

EXHIBIT C

SCALING INSTRUCTIONS -- LOCATION APPROVAL -- BRAND INFORMATION

(1) ORIGINAL REGISTRATION Date _____
 REVISION NUMBER _____ Date _____
 CANCELLATION Date _____

(2) TO: _____
 (Third Party Scaling Organization)

(3) FROM: Tillamook (06) Phone (503) 842-2545
 (State Forestry District)
 Address 5005 Third St., Tillamook, OR 97141

(4) PURCHASER: _____
 Address _____

(12) SALE NAME Trask Cutoff

COUNTY Tillamook

(13) STATE CONTRACT NUMBER 341-07-01

(14) SCALE: westside eastside cubic foot

(15) STATE BRAND REGISTRATION NUMBER _____

(16) BUREAU BRAND CODE NUMBER _____

(17) STATE BRAND INFORMATION:

(COMPLETE)

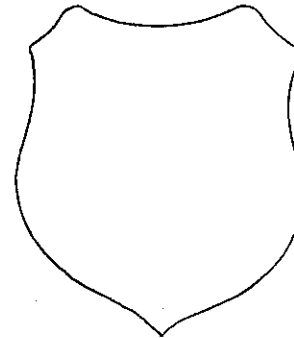

(5) MINIMUM SCALING SPECIFICATIONS			CLASS		
SPECIES	SCALING DIAMETER INCHES	*NET SCALE VOLUME	PER MBF	** SUM	SUB
Conifers	--	10	X		
Hardwoods				X	

* Apply minimum volume test to whole logs over 40' Westside; 20' Eastside.
 ** Sum (if indicated): see instructions and explain in Item (20).

(6) WESTSIDE SCALE: YES NO
 Actual taper all logs over 40' scaling length

(7) EASTSIDE SCALE: YES NO
 *Actual taper butt logs over 40' scaling length

(8) PENCIL BUCK YES NO
 back to Minimum Scaling Diameter _____

(9) ADD-BACK VOLUME -- YES NO
 Deductions due to delay

(18) PAINT REQUIRED: YES
 COLOR Orange

(19) SPECIAL SCALES
PEELABLE CULL (all species)
UTILITY/PULP (all species)
NO DEDUCTIONS ALLOWED FOR MECHANICAL DAMAGE
OTHER: _____
OTHER: _____

(10) APPROVED SCALING LOCATIONS	Species	Yard	Truck

(20) REMARKS: Loads containing only SUM material need not be accounted for by scale ticket.

Operator's Name (Optional inclusion by District): _____

(11) NOTICE OF CANCELLATION OF BRAND:
 Effective Date: _____

State Forester's Representative

(21) SIGNATURES:

 Purchaser or Authorized Representative Date

 State Forester Representative Date

Notify the District within one hour when branding or painting is inadequate for quick identification, the receipts are missing, not correctly or completely filled out, and/or when logs presented for scaling are impossible to scale accurately.

Distribution: ORIGINAL: Salem / COPIES: TPSO (4), Purchaser, Operator, District, Mgmt. Unit

EXHIBIT C

INSTRUCTIONS FOR FORM 343-307 (rev. 5/01)

- (1) Check appropriate box. REVISION NUMBER requires comments. CANCELLATION requires Item (21). Complete date.
- (2) Designate Third Party Scaling Organization (TPSO). Send 4 copies to TPSO, 1 to purchaser, 1 to Salem, and keep such copies as to district needs.
- (3) State District office, address and phone.
- (4) Enter Purchaser's business name and address as it appears on the Contract.
- (5) Minimum Scaling Specifications. Review Section 2040 or 2045, "Log Removal," of the Contract. Species, or combined species can be separate entries. Information serves as a basis for scaling (see also Items (13) thru (17)), and is required to show existence on the sale. **PerM** (per MBF). **SUM** (lump sum material). **SUB** (submerchantable material. SUB, as used by the State, references that material containing at least 10 bf (net) but less than the lower merchantable net volume limit or grade requirements for other merchantable (PerM) entries. PerM, SUM, and Sub must be indicated by checking the appropriate column. Species with the same specifications and value are combined into one entry. PerM and Sub require scaling therefore complete specifications. SUM need not be scaled, hence no specifications. Loads containing only SUM are to be ticketed if so instructed in Item (19). Mixed loads of SUM, PERM and/or subspecies will always be scaled.
- (6) Westside -- actual taper segment scale. Check Yes or No. Special Service Rules on file with TPSO. See: Segment Scaling and Grading of Long Logs -- All Species -- State Forestry Department Scaling Practices (Westside).
- (7) Eastside -- actual taper/taper table segment scale. Special Service Rules on file with TPSO. See: Segment Scaling and Grading of Long Logs -- All Species -- State Forestry Department Scaling Practices (Eastside). Items with * follow U.S. Forest Service Eastside rules.
- (8) Pencil Buck. Check NO if a westside sale, optional for eastside sales.
- (9) Add-Back Volume. Add-Back is normally checked YES. Scaler records deductions (sap rot, weather checks, etc.) caused by an abnormal delay in removal. Enter separately on scale ticket. TPSO provides State with summaries that include this as a net volume by species. Salvage sales and certain other circumstances may require that "NO" be checked.
- (10) Show scaling locations only applicable to TPSO. Not necessary to list markets. If all species are scaled at same location, enter "ALL."
- (11) When logging is complete, recall branding hammers, date and sign where indicated, check CANCELLATION box at top of form, and send to TPSO.
- (12) Enter sale name and county.
- (13) Enter sale Contract number.
- (14) Check Westside or Eastside log scale. Cubic foot refers to Northwest Log Rules Cubic Foot Scale.
- (15) Oregon Forest Products Brand Registry Number (optional).
- (16) DO NOT USE -- TPSO will fill in when applicable.
- (17) Show one brand only. Complete drawing. If more than one brand is assigned to the sale, (1) make separate form for each brand, and (2) on each form, explain and show other brand(s) under REMARKS, Item 19.
- (18) Check YES and designate orange.
- (19) Special Scales. These are the Special Scales that will be applied. If "Other" is indicated, please describe. Give comments in Item (19).
- (20) Use this space to designate weight conversion factors, or any other explanations to clarify scaling requirements. If additional scaling locations are approved, prepare another form showing all (old and new) locations. Check REVISION box at top of form and explain under remarks. Route as indicated.
- (21) Require purchaser to sign and date completed form.

EXHIBIT D
 FOREST ROAD SPECIFICATIONS

SUBGRADE WIDTH	SURFACED WIDTH	POINT TO POINT	STATION TO STATION	DRAINAGE	DITCH DEPTH FROM FINISHED SURFACE (Feet)	DITCH DEPTH FROM SUBGRADE (Feet)
14 feet	12 feet	0+00 to 3+00	A to B	Outslope	---	---
16 feet	12 feet	3+00 to 5+50	A to B	Ditch	3	1.5
14 feet	12 feet	0+00 to 16+00	C to D	Outslope	---	---
14 feet	12 feet	0+00 to 9+00	E to F	Outslope	---	---
16 feet	12 feet	0+00 to 3+50	G to H	Ditch	3	1.5
14 feet	12 feet	3+50 to 6+70	G to H	Outslope	---	---
16 feet	12 feet	6+70 to 10+00	G to H	Ditch	3	1.5
14 feet	12 Feet	10+00 to 13+70	G to H	Outslope	---	---
14 feet	12 Feet	0+00 to 8+50	I to J	Outslope	---	---

CLEARING. This work shall consist of clearing, removing, and disposing of all trees, Snags, Down Timber, brush, surface objects, and protruding obstructions within the clearing limits.

Where clearing limits have not been marked, the "Road Brushing Specifications" in Exhibit D shall apply. Clearing debris shall not be placed or permitted to remain in or under any road embankment sections. Clearing debris shall not be left lodged against standing trees.

All danger trees, leaners, and Snags outside the clearing limits which could fall and hit the road shall be felled.

GRUBBING. This work shall consist of the removal or digging out of stumps and protruding objects.

All stumps shall be completely removed within the limits of required grubbing. Stumps overhanging cutslopes shall be removed. Grubbing debris shall not be placed or permitted to remain in or under any road embankment sections. Grubbing debris shall not be left lodged against standing trees. Grubbing classifications are as follows:

New construction - From the top of the cutslope to the toe of the fill.

Improvements and reconstructions - 4 feet back from the shoulder of the subgrade or the ditch, whichever is widest, or as marked in the field.

Trees outside the clearing limits shall not be felled unless approved in writing by STATE.

CLEARING AND GRUBBING DISPOSAL. Scatter through openings in the timber outside of the cleared right-of-way, except areas where end-haul is required.

EXHIBIT D
FOREST ROAD SPECIFICATIONS

EXCAVATION. Excavation and grading shall not be done when weather and/or ground conditions are such that damage will result to existing subgrade or cause excessive erosion.

Excavation shall conform to STATE-engineered lines, grades, dimensions, and plans when provided.

All suitable excavated material shall be used where possible for the formation of fills, shoulders, and drainage structure backfills. Embankment materials shall be free of woody debris, brush, muck, sod, frozen material, and other deleterious materials. All fills and drainage structure backfills shall be machine compacted according to the specifications in Exhibit E.

Unless road design plans show otherwise, all roads shall be on a balanced cross section, except when the slope is over 50 percent, the road shall be on full bench for the width specified.

Excess excavation shall not be sidecast where material will enter a stream course or where material will accumulate in areas deemed a high landslide hazard location by STATE.

Bank excavation and sidecast pullback on a project road segment shall be completed prior to subgrade approval.

ROAD WIDTH LIMITATIONS. PURCHASER shall obtain advance written approval from STATE to construct the road to a greater width than specified. Extra subgrade width shall be required for:

Fill Widening. Add to each fill shoulder 1 foot for fills 3 feet to 6 feet high; 2 feet for fills over 6 feet high.

Curve Widening. Widen the inside shoulder of all curves as follows: 400 divided by the radius of the curve equals the amount of extra width.

DRAINAGE

Ditch. Construct ditch as specified in Exhibit D. Subgrade shall be crowned at 4 to 6 percent. Construct ditchouts away from subgrade at locations marked in the field.

Outslope. Road subgrade shall be outsloped at 4 to 6 percent.

Outslope. Road subgrade shall be outsloped at 4 to 6 percent.

TURNOUTS. Increase roadbed width an additional 8 feet for both subgrade and surfacing. Length shall be at least 25 feet, or as staked on the ground, plus 25-foot approaches at each end.

Location: As marked in the field.

GRADING

Rock
Common -
Common - turnpike (level) section

Back Slopes
Vertical to 1/4:1
3/4:1
2:1

Fill Slopes
Not steeper
than 1 1/2:1

Top of cutslope shall be rounded.

LANDINGS. Landings shall be constructed no more than 70 feet wide. Surface shall be crowned for drainage.

TURNAROUNDS. Increase subgrade width an additional 30 feet for a length of 16 feet with 20' radius returns at locations marked in the field.

EXHIBIT D
ROAD BRUSHING SPECIFICATIONS



Clearing Limits

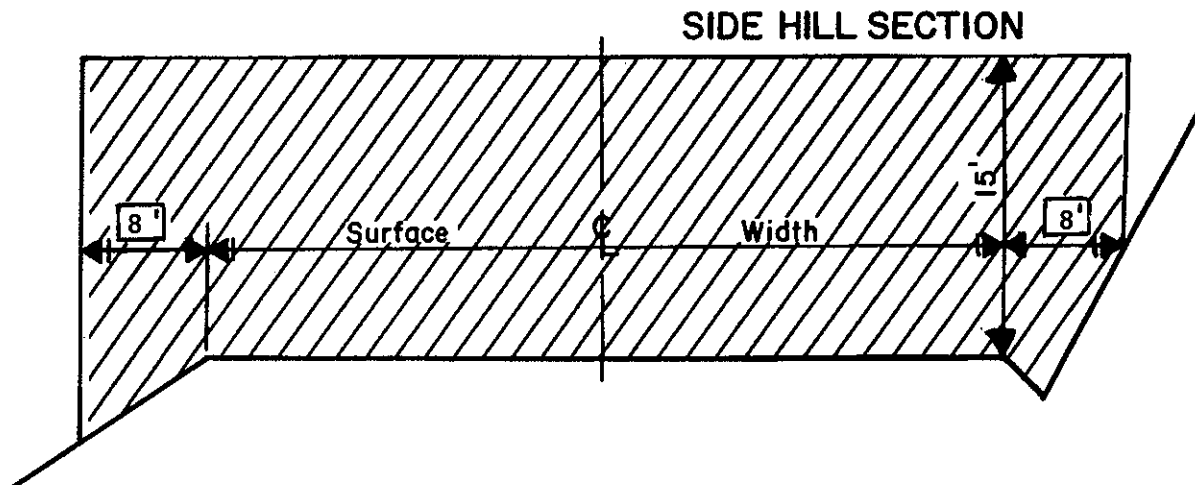

REQUIREMENTS

Unless otherwise approved in writing by STATE, brush and trees less than 6 inches DBH shall be cut to a height of 6 inches or less above the ground surface or obstructions such as rocks or existing stumps. Brushing on project road segments shall be completed prior to subgrade approval.

Debris resulting from the brushing operation shall be removed from the roadway, cutslope, ditches, and water courses within 72 hours and may be scattered downslope from the road or placed in other stable locations, unless otherwise approved by STATE.

Trees outside the clearing limits shall not be felled unless approved in writing by STATE.

EXHIBIT E
 ROAD SURFACING

Note: The conversion from compacted yardage to truck yardage is 1.2 multiplied by the compacted yardage equals truck yardage.

TYPE OF ROCK	COMPACTED DEPTH	POINT TO POINT	STATION TO STATION	APPROX. TOTAL TRUCK MEASURE VOLUME
Pit-Run	12 "	A to B	0+00 to 5+50	342 CY
Pit-Run	12 "	C to D	0+00 to 16+00	994 CY
Pit-Run	12 "	E to F	0+00 to 9+00	559 CY
Pit-Run	12 "	G to H	0+00 to 13+70	851 CY
Pit-Run	12 "	I to J	0+00 to 8+50	528 CY
TURNOUTS:		NO. OF T.O.	POINT TO POINT	
Pit-Run	12 "	1	A to B	20 CY
Pit-Run	12 "	3	C to D	60 CY
Pit-Run	12 "	2	E to F	40 CY
Pit-Run	12 "	2	G to H	40 CY
Pit-Run	12 "	2	I to J	40 CY
TURNAROUNDS:		NO. OF T.A.		
Pit-Run	12 "	1	G to H	32 CY
MISCELLANEOUS:	USE	POINT TO POINT	STATION	
Pit-Run	Landing Rock	A to B	5+50	50 CY
Pit-Run	Jct. Rock	A to B	0+00	20 CY
Pit-Run	Jct. Rock	C to D	0+00	40 CY
Pit-Run	Landing Rock	C to D	16+00	50 CY
Pit-Run	Landing Rock	E to F	0+00	50 CY
Pit-Run	Jct. Rock	E to F	9+00	40 CY
Pit-Run	Jct. Rock	G to H	0+00	40 CY
Pit-Run	Landing Rock	G to H	13+70	50 CY
Pit-Run	Jct. Rock	I to J	0+00	40 CY
Pit-Run	Landing Rock	I to J	8+50	50 CY

EXHIBIT E
ROCK SPECIFICATIONS

Materials. The material shall be fragments of rock or other hard, durable particles crushed to the required size and a filler of finely crushed stone, sand, or other finely divided mineral matter. The material shall be free from vegetation and lumps of clay.

Quality and Grading Requirements. The stone base materials shall be crushed rock, including sand. River gravel shall not be used.

The material from which base material is produced or manufactured shall meet the following test requirements:

Hardness - Test Method AASHTO T 96 35% Maximum

Durability - Test Method ODOT TM 208
Passing No. 20 Sieve: 30% Maximum
Sediment Height: 3" Maximum

Roads shall be uniformly graded and approved by STATE prior to rocking.

Additional rock for curve widening is required and has been included in the volume estimates.

Turnouts, turnarounds, Landings and junctions shall be rocked concurrently with the road.

Roads shall be uniformly graded and approved by STATE prior to rocking. For typical cross section, turnout and turnaround see Forestry Department Drawing Nos. 351-C, 351-D and TOTA-1 at the Forestry Department district office.

CRUSHED ROCK SPECIFICATIONS

<u>For Pit-Run</u>	Passing	10" sieve	100%
	Passing	6" sieve	60-85%
	Passing	3" sieve	30-50%
	Passing	¼ " sieve	10% maximum

Control of pit-run gradation shall be by visual inspection by STATE. Pit-run shall be reasonably free of organic material and shall not contain an excessive amount of oversized (cobbles or boulders) or undersized (clay, silt or sand) particles.

The referenced sieve shall have square openings as set forth in AASHTO M 92, Woven Cloth Series. The determinations of size and gradings shall be as set forth in AASHTO T 27.

EXHIBIT E
ROCK ACCOUNTABILITY

PURCHASER shall obtain STATE approval for subgrades prior to rocking. Rocking must be done only when weather conditions are acceptable to STATE, and must be suspended when muddy water could enter streams.

Rock accountability shall be determined by depth measurement. STATE shall be given 24 hours' notice prior to rocking.

Depth Measurement. Road rock shall be spread and compacted according to the depths specified in Exhibit E. Truck measure volumes are given, but shall not limit the amount of rock spread.

Depth shall be determined in the most compacted area of the surface cross section. If additional rock is required because of insufficient depth, it shall be added by truck measure to those areas that were slighted. The conversion from compacted yardage to truck yardage is 1.2 multiplied by the compacted yardage equals truck yardage.

The depth of compacted aggregates shall not vary more than 1 inch from the depth specified in Exhibit E. The average depth for each road segment shall be the specified depth or greater.

Junctions shall have a surfaced area as marked in the field at the compacted depths specified in Exhibit E.

Turnouts shall have a surfaced area of at least 44 square yards each at the depths shown in Exhibit E.

Turnarounds shall have a surfaced area of at least 73 square yards each at the depths shown in Exhibit E.

Landings shall have a surfaced area as marked in the field at the depths shown in Exhibit E.

Curve Surfacing. Extra surface width shall be required for the inside of all curves as follows: 400 divided by the radius of the curve equals the amount of extra width to be surfaced at the depths shown in Exhibit E.

EXHIBIT E

COMPACTION AND PROCESSING REQUIREMENTS

Subgrade. Subgrade surfaces of the road segments listed below shall be graded and compacted prior to rocking. Compaction shall be accomplished by traveling all surfaces from shoulder to shoulder until visible deformation ceases, or in the case of a sheepsfoot roller, the roller "walks out." At least 3 passes shall be made over the entire width and length of the road. A pass is defined as traveling a road section in one direction and then back over that same section again. Compaction shall be accomplished by using the approved equipment listed below or others approved by STATE.

ROAD SEGMENT	COMPACTION EQUIPMENT OPTIONS
ALL	Vibratory Roller

Fills. Embankments and fills shall be placed in (approximately) horizontal layers not more than 8 inches in depth. Each layer shall be separately, and thoroughly, compacted. Compaction equipment shall be operated over the entire width of each layer until visible deformation of the layers ceases or, in the case of a sheepsfoot roller, the roller "walks out." At least 3 passes shall be made over the entire width and length of each layer. A pass is defined as traveling a fill layer in one direction and then back over that same layer again.

Placing individual rocks or boulders with more depth than the allowed layer thickness shall be permitted, provided the embankment will accommodate them. Such rocks and boulders shall be at least 6 inches below the subgrade. They shall be carefully distributed and the voids filled with finer material, forming a dense and compacted mass. Compaction shall be accomplished by using the approved equipment listed below or others approved by STATE:

ROAD SEGMENT	COMPACTION EQUIPMENT OPTIONS
ALL	Crawler Tractor

Pit-Run Rock. Pit-run surfacing rock shall be spread on roads with a crawler tractor and continuously walked-in. Rock spreading shall begin at nearest point from the rock source and progress toward the end of the project, unless otherwise approved in writing by STATE. Compaction shall be accomplished by using the approved equipment listed below or others approved by STATE:

Rock shall be compacted and processed during the same project period it is spread, unless otherwise approved in writing by STATE.

Rock shall be crowned or outsloped at 4 to 6 percent unless otherwise specified.

ROAD SEGMENT	COMPACTION EQUIPMENT OPTIONS
ALL	Vibratory Roller

Vibratory Rollers. The drum shall have a smooth surface, a diameter not less than 48 inches, a width not less than 58 inches, and a turning radius of 15 feet or less. Vibration frequency shall be regulated in steps to 1400, 1500, and 1600 VPM, corresponding to engine speeds of 1575, 1690, and 1800 RPM. The centrifugal force developed shall be 7 tons at 1600 VPM. It shall be activated by a power unit of not less than 25 horsepower. The vibratory roller shall be self-propelled and operated at speeds ranging from 0.9 miles to 1.8 miles per hour, as directed by STATE.

EXHIBIT F

ROCK PIT DEVELOPMENT AND USE

- (1) PURCHASER shall conduct the Operations relative to the disposal of waste material in such manner that silt, rock, debris, dirt, or clay shall not be washed, conveyed, or otherwise deposited in any stream. All waste shall be deposited at an approved "waste disposal site."
- (2) Where overburden removal limits have not been marked, they shall extend for a distance of at least 20 feet beyond the developed rock source. Overburden removal limits, when marked, are designated by orange right-of-way boundary tags. Overburden and woody debris shall be hauled to a designated waste area. All merchantable timber shall be felled and decked. Overburden shall be spread evenly, grass seeded, and compacted at the waste area and woody debris stacked separately. Prior to drilling or rock removal, completion of overburden removal shall be approved in writing by STATE.
- (3) The rock pit floor shall be developed to provide drainage away from the rock pit. Rock pit drainage ditches shall be developed and maintained. Benches shall be constructed at intervals of 40 feet or less in height and shall be a minimum of 20 feet in width. Any gravel or talus slopes shall be left with a working face at an angle of 60 degrees or less. There shall be a minimum of 1 bench with an access road to it. All benches shall have an access road to them. Said benches shall be easily accessible with tractors.
- (4) The STATE shall be notified two working days prior to the beginning of drilling operations. Working days shall be defined as Monday through Thursday, 6:00 a.m. to 4:30 p.m.
- (5) Controlled blasting techniques shall be utilized for any blasting operations, and shall be accomplished using timing devices, delayed charges, low intensity shots, or other suitable means to contain all material in the rock pit prism (full containment). Each low intensity shot shall be shot into the previous shots' void in order to contain all the material in the rock pit prism. Each shot shall also have a "tattle-tale" end cap so that it is known if all charges were detonated. The purchaser shall detonate or remove all non-detonated explosives from STATE LANDS. PURCHASER shall maintain a comprehensive log that contains all pertinent data for all blasting operations. The blasting log shall be submitted to the STATE after the completion of all blasting activity. The blasting log is intended for STATE record keeping purposes only.
- (6) Pit face shall be developed in a uniform manner.
- (7) Oversized material that is produced shall be piled in the vicinity of the pit. It shall not be wasted.
- (8) PURCHASER shall prepare a written development plan for the pit area. The plan shall be submitted to STATE for approval prior to conducting any operation in the pit area.
The plan shall include, but not be limited to:
 - (a) Location of benches and roads to benches.
 - (b) Disposal site for debris and overburden.
 - (c) Time lines for rock quarry use.
 - (d) Erosion control measures.
 - (e) Oversized material location.
- (9) PURCHASER shall schedule and coordinate quarry and stockpile usage with other existing or planned STATE contracts requiring quarry and stockpile usage.
- (10) PURCHASER shall notify STATE 5 days prior to the start of quarry development activities.
- (11) Upon completion of use, the pit site and access roads shall be left in a condition free from overburden and debris. Rock pit roads shall be waterbarred to provide drainage as specified in Exhibit H and blocked as directed by STATE.

EXHIBIT G

CULVERT SPECIFICATIONS

All culvert materials shall be furnished and installed by PURCHASER, unless otherwise specified in the Contract. Culverts shall be constructed of corrugated polyethylene. Culverts shall conform to the material and fabricating requirements of the "Standard Specifications for Highway Construction" prepared by the Highway Division of the Oregon State Department of Transportation. Polyethylene culverts shall also be double walled and meet the requirements of AASHTO M-294-901, Type S. Corrugation types and shapes other than those meeting the above minimum Highway requirements, shall be approved in writing by STATE.

Culverts shall be located according to the alignment and grade as shown on the Plan and Profile, and/or as staked in the field, or as stipulated in special instructions.

The STATE Representative shall determine final culvert locations and stake the locations in the field prior to installation.

Culvert grade shall slope away from ditch grade at least 5 percent unless otherwise specified.

The foundation and trench walls for all culverts shall be free from logs, stumps, limbs, stones, and other objects which would dent or damage the pipe. The culvert trench shall be excavated 3 pipe diameters wide to permit compaction and working on each side of the pipe. Tamping shall be done in 6-inch lifts, 1 pipe diameter each side of the pipe to 95 percent density or over. Bedrock shall be excavated as required to provide a uniform foundation for the full length of the culvert. Minimum bedding depth shall be 6 inches.

A bedding of granulated material or crushed rock as specified shall be placed to provide a wide band of support and to transmit the load from above evenly over the entire length of the pipe.

Backfill shall consist of granulated material, crushed rock, or job-excavated soil free of stumps, limbs, rocks, or other objects which would damage the pipe.

Transporting of the pipe shall be done carefully. Dragging or allowing free fall from trucks or into trenches shall not be permitted.

Joining shall be done with bands of like material and corrugations. Manufacturers' instructions shall be followed for prefabricated pipe assembly.

Polyethylene joints shall be made with split couplings, corrugated to engage the pipe corrugations, and shall engage a minimum of 4 corrugations, 2 on each side of the pipe joint.

When joints are employed, the longest length of pipe shall be placed at the outlet end.

A manufacturer's certification that the product was manufactured, tested, and supplied in accordance with this specification shall be furnished to the Project Engineer upon request.

EXHIBIT G
CULVERT SPECIFICATIONS

Minimum height of cover over top of culvert to subgrade when road is to be rocked shall be 12 inches. Minimum vertical cover for other designs shall be as specified by STATE.

Lengths of individual culvert sections shall be not less than 10 feet, unless otherwise provided for in special instructions. The shortest culvert section length shall be placed at the inlet end.

The ends of each culvert shall be free of logs and debris which would restrict the free flow of water. The intake end of relief culverts shall be provided with a sediment catching basin 3 feet in diameter at the bottom. The outlet end of any culvert which would allow water to erode embankment soil shall be provided with an approved slope protection device. Construct lead-off ditches away from culvert outlets where the slope gradients restrict the free flow of water.

CULVERT NO.	DIAMETER (Inches)	LENGTH (Feet)	ROAD SEGMENT POINT TO POINT	STATION
1	18"	28	A to B	3+00
2	18"	40	C to D	0+00
3	18"	30	E to F	6+80
4	18"	40	G to H	0+00
5	18"	30	G to H	6+70

The intake end of culverts shall be marked by installing a 5-foot long, painted steel fence post 2 feet into the ground, within 6 inches of the inlet on the downgrade side.

EXHIBIT H
 WATERBAR SPECIFICATIONS

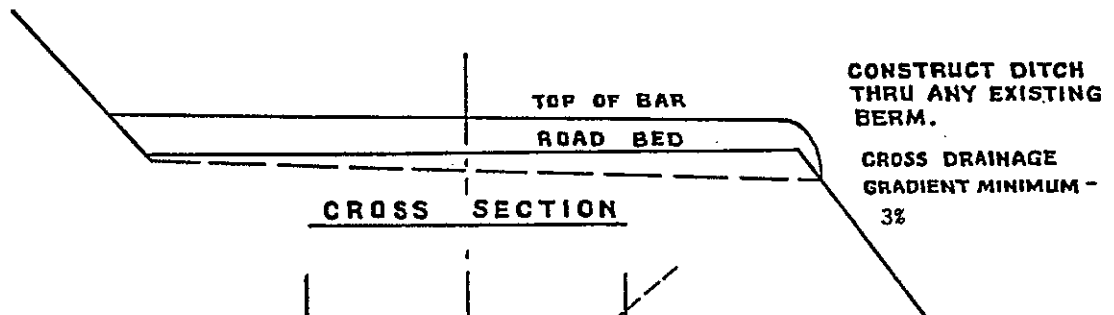
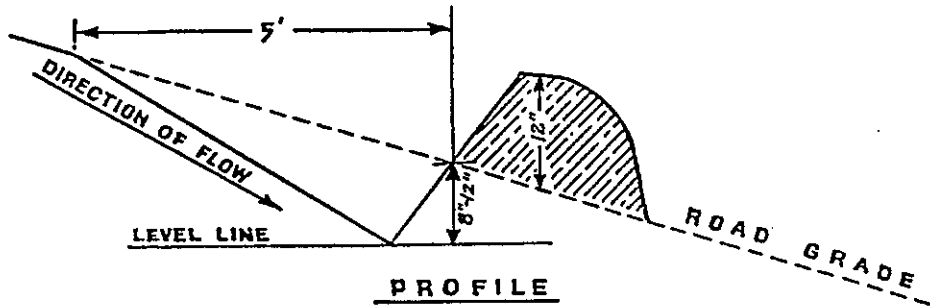

SPACING OF WATERBARS

ROAD GRADE	DISTANCE
≤ 5%	600'
6-10%	300'
11-15%	150'
16-20% or greater	100'

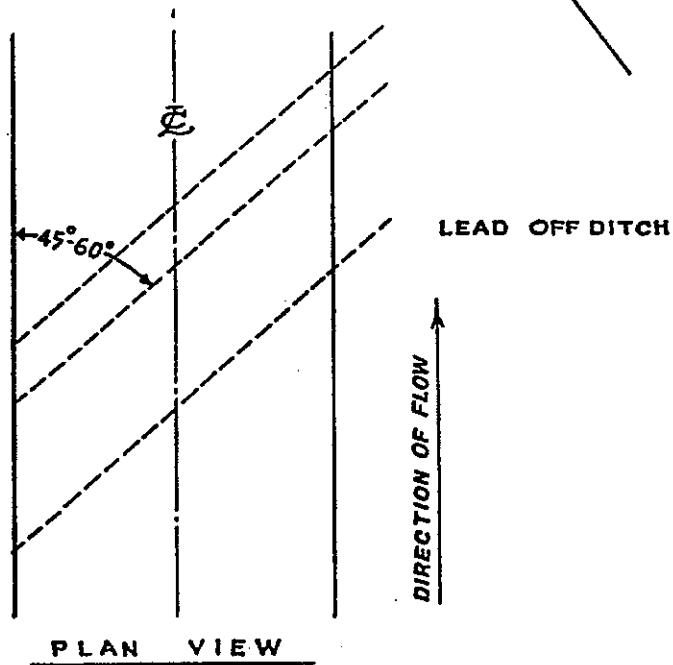

**WATERBAR SPECIFICATIONS
 FOR CROSS DITCHING #298**

EXHIBIT I

SEEDING AND FERTILIZING

This work shall consist of preparing seedbeds and furnishing and placing required seed and fertilizer.

Seeding Seasons. Seeding shall be performed only from March 1 through June 15 and August 15 through October 15. Seeding materials shall not be applied during windy weather or when the ground is excessively wet or frozen. Areas of disturbed soil shall be seeded by the end of the project period in which work was started. PURCHASER shall notify STATE 24 hours prior to seeding.

Soil Preparation. Areas to be seeded that have been damaged by erosion or other causes shall be restored prior to seeding. All areas to be seeded shall be finished and then cultivated to provide a reasonably firm, but friable seedbed. A minimum of 1/2 inch of surface soil shall be in a loose condition.

Application Methods for Seed and Fertilizer

Dry Method. Mechanical seeders, seed drills, landscape seeders, cultipacker seeders, fertilizer spreaders or other approved mechanical seeding equipment shall be used to apply the seed and fertilizer in the amounts and mixtures specified. Hand-operated seeding devices may be used when seed and fertilizer are applied in dry form.

Application Rates for Seed and Fertilizer

Seed listed below shall be applied at the following rates per acre:

<u>Species</u>	<u>Lb./Acre</u>	<u>Mixture</u>	<u>Pure Live Seed</u>	<u>Poison and/or Repellent</u>
Fine Fescue	12	40%	98%	0
Annual Ryegrass	6	20%	98%	0
Perennial Ryegrass	9	30%	98%	0
White Dutch Clover	3	10%	98%	0

Fertilizer: Chemical analysis shall be 16-20-0 and shall be applied at the rate of 300 pounds per acre.

Seeding will be considered acceptable when all other specified requirements in Exhibits I and J have been completed and a healthy, uniform, close stand of grass has been established, unless otherwise approved in writing by STATE.

State Timber Sale Contract
No. 341-07-01
Trask Cutoff

EXHIBIT J

MULCHING

This work shall consist of furnishing and placing required mulch. Mulch shall consist of straw that is free of noxious weeds.

Mulching Period. Straw mulch shall be applied within 24 hours of spreading grass seed and fertilizer.

Application Rates for Mulch

Place straw mulch to a reasonably uniform thickness of 3/4 to 1¼ inches. This rate requires between 1 and 1½ tons of dry mulch per acre.

EXHIBIT K

OHV TRAIL FILTER FOR MC TRAIL

NOT TO SCALE

Blocking materials minimum size should be 3'x3', either boulders, root wads, or cull logs. Blocking materials shall be touching and extend to the edges of roadway, or skid trail.

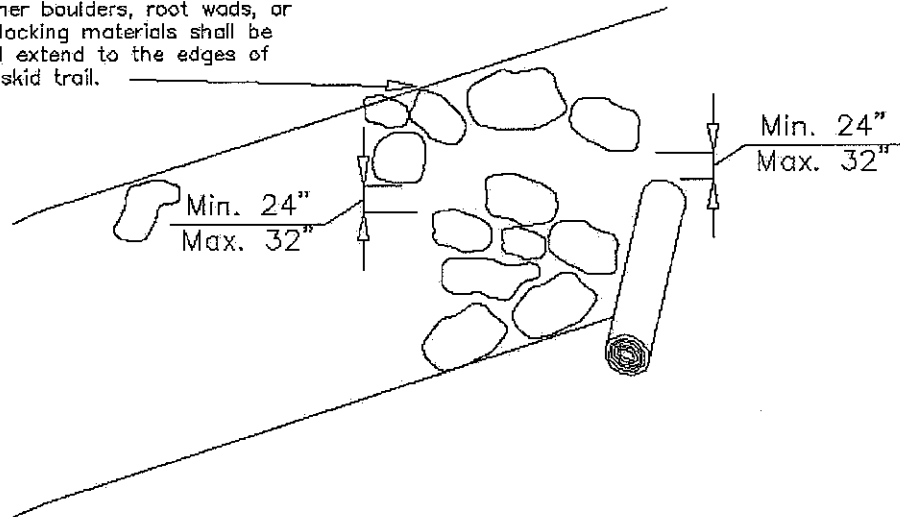

PLAN VIEW

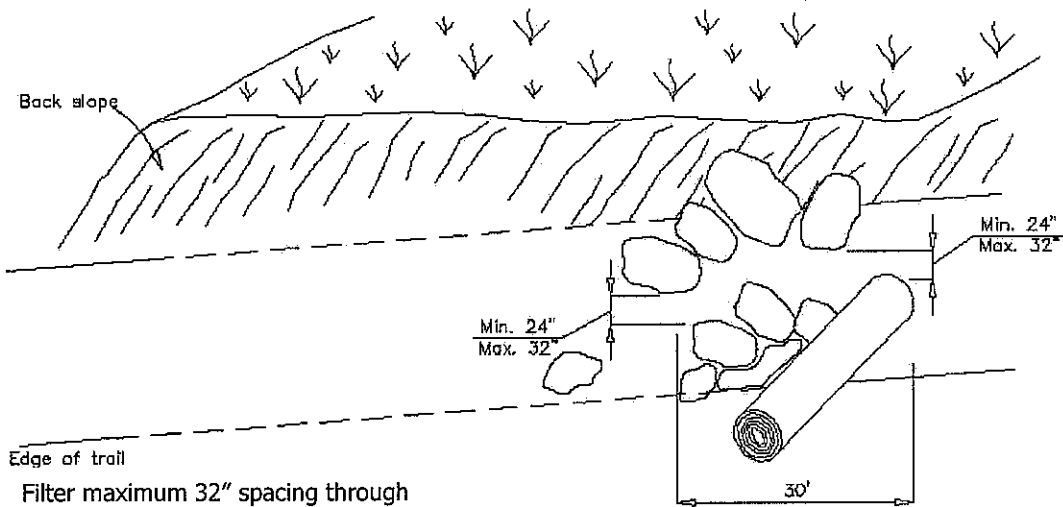

Filter maximum 32" spacing through path entrance and exit. 6'-8' curve radius through filter. Overall length of filter should be 30'. Boulders used as blocking material should be buried 1/3 of original height.

PROFILE

PART IV: OTHER INFORMATION



"STEWARDSHIP IN FORESTRY"

WRITTEN PLAN

SALE NAME: Trask Cutoff 341-07-01

PROTECTED WATERS: Johnson Creek, Type 'F' Stream

Definitions: Stream buffer: at least 100 feet horizontal distance from the high water mark on each side of the stream.

LOCATION: Portions of Sections 23, T1S, R8W, W.M., Tillamook County.

Activity: Cable lines across stream

Protection measures:

- All trees, outside of cable corridors, in the RMA are reserved from cutting.
- Trees felled for cable corridors within the RMA will be incidental and will not be removed.
- Cable yarding lines will be pulled out of the RMA prior to rigging the next yarding road.
- If trees or logs fall or slide into a stream channel they will be not be limbed, bucked, or removed.
- Cable corridors will be an average of at least 150 feet apart where they extend over or through the Type F stream and buffer.

Date: September, 2006

Prepared by: Katherine Skinner