

EXHIBIT "B"

FOREST ROAD SPECIFICATIONS

SUBGRADE WIDTH	SURFACED WIDTH	POINT TO POINT	STATION TO STATION	DRAINAGE
14 feet	12 feet	A to B	0+00 to 63+50	Outslope
14 feet	12 feet	C to D	0+00 to 153+90	Ditch
14 feet	12 feet	E to F	0+00 to 10+35	Ditch
14 feet	12 feet	E to F	10+35 to 15+70	Outslope
14 feet	12 feet	E to G	0+00 to 32+00	Ditch
14 feet	12 feet	E to G	32+00 to 47+10	Outslope
14 feet	12 feet	H to I	0+00 to 3+40	Outslope

**CLEARING.** This work shall consist of clearing, removing, and disposing of all trees, snags, down timber, brush, surface objects, and protruding obstructions within the clearing limits.

Where clearing limits have not been marked, the "Road Brushing Specifications" in Exhibit B shall apply. Clearing debris shall not be placed or permitted to remain in or under any road embankment sections. Clearing debris shall not be left lodged against standing trees.

All danger trees, leaners, and snags outside the clearing limits which could fall and hit the road shall be felled.

**GRUBBING.** This work shall consist of the removal or digging out of stumps and protruding objects.

All stumps shall be completely removed within the limits of required grubbing. Stumps overhanging cutslopes shall be removed. Grubbing debris shall not be placed or permitted to remain in or under any road embankment sections. Grubbing debris shall not be left lodged against standing trees. Grubbing classifications are as follows:

New construction - From the top of the cutslope to the toe of the fill.

Improvements and reconstructions - 4 feet back from the shoulder of the subgrade or ditch, whichever is widest, or as marked in the field.

**CLEARING AND GRUBBING DISPOSAL.** Scatter through openings in the timber outside of the cleared right-of-way, except areas where end-haul is required.

EXHIBIT "B"

FOREST ROAD SPECIFICATIONS

**EXCAVATION.** Excavation and grading shall not be done when weather and/or ground conditions are such that damage will result to existing subgrade or cause excessive erosion.

Excavation shall conform to STATE-engineered lines, grades, dimensions, and plans when provided.

All suitable excavated material shall be used where possible for the formation of fills, shoulders, and drainage structure backfills. Embankment materials shall be free of woody debris, brush, muck, sod, frozen material, and other deleterious materials. All fills and drainage structure backfills shall be machine compacted according to the specifications in Exhibits C and E.

Unless road design plans show otherwise, all roads shall be on a balanced cross section, except when the slope is over 50 percent, the road shall be on full bench for the width specified.

Excess excavation shall not be sidecast where material will enter a stream course or where material will accumulate in areas deemed a high landslide hazard location by STATE.

**ROAD WIDTH LIMITATIONS.** PURCHASER shall obtain advance written approval from STATE to construct the road to a greater width than specified. Extra subgrade width shall be required for:

**Fill Widening.** Add to each fill shoulder 1 foot for fills 3 feet to 6 feet high; 2 feet for fills over 6 feet high.

**Curve Widening.** Widen the inside shoulder of all curves as follows: 400 divided by the radius of the curve equals the amount of extra width.

**DRAINAGE**

**Ditch.** Construct "V" ditch 3 feet wide and to a depth of 1 foot below subgrade. Subgrade shall be crowned at 4 to 6 percent. Construct ditchouts away from subgrade at locations marked in field.

**Outslope.** Road subgrade shall be outsloped at 4 to 6 percent.

**TURNOUTS.** Increase roadbed width an additional 8 feet for both subgrade and surfacing. Length shall be at least 25 feet, or as staked on the ground, plus 25-foot approaches at each end.

Location: As marked in the field.

**JUNCTIONS.** Increase roadbed width to allow a curve radius of a least 50 feet, or as marked in the field.

**GRADING**

	<u>Back Slopes</u>	<u>Fill Slopes</u>
Rock	Vertical to 1/4:1	Not steeper
Common	3/4:1	than 1½:1

Top of cutslope shall be rounded.

**TURNAROUNDS.** Increase subgrade width an additional 20 feet for a length of 20 feet at locations marked in the field.

EXHIBIT "B"

ADDITIONAL INSTRUCTIONS

**A to B** Widen road subgrade 10 feet to the right to improve alignment between Stations 2+00 and 3+00.

Construct waterbars between Stations 43+90 and 62+50 according to the specifications in Exhibits C and F, and as marked in the field.

Establish profile grade at 17 percent or less between Stations 49+50 and 54+20.

**C to D** Remove existing culverts from the following locations according to the specifications in Exhibit E: Stations 59+80 and 118+80. Reestablish subgrade with suitable onsite material.

Retrieve sidecast material between the following Stations according to the specifications in Exhibits B and G, and as marked in the field: 29+00 to 34+10, 38+10 to 81+60, 98+90 to 104+00, 106+90 to 113+40, 114+65 to 138+05, and 140+80 to 143+15.

Remove berm between roadway and fill slope to subgrade elevation and outslope at least 4 to 6 percent between Stations 14+50 and 16+90, and 27+45 and 29+00. Excavated material shall be scattered outside of right-of-way.

Remove berm between roadway and fill slope to subgrade elevation and outslope at least 4 to 6 percent between the following Stations: 5+50 to 9+00, 11+90 to 12+20, 79+40 to 81+30, and 93+25 to 94+25.

Remove material from the left side of through-cut to construct a leadoff ditch between Stations 13+10 and 13+50, as marked in the field.

Remove existing waste piles to the left of Station 133+77 and outslope at least 4 to 6 percent according to the specifications in Exhibit B.

Widen road subgrade 8 feet to the right to improve alignment between the following Stations: 41+65 to 43+10, 63+10 to 78+10, 115+80 to 116+25, 123+75 to 125+60, and 128+90 to 130+60.

Widen road subgrade 7 feet to the right to improve alignment between the following Stations: 116+25 to 118+50, and 140+80 and 142+20.

Widen road subgrade 6 feet to the right to improve alignment between the following Stations: 100+80 to 102+25, and 131+65 to 133+00.

Widen road subgrade 4 feet to the right to improve alignment between the following Stations: 59+80 to 62+30, 98+90 to 100+80, 123+10 to 123+75, and 127+80 to 128+90.

Install culvert markers at the following Stations according to specifications in Exhibit E: 34+35, 36+82, 43+30, 49+40, 67+00, 73+00, 81+30, 85+55, and 153+70.

Construct vertical road dip in the subgrade between Stations 10+25 and 11+50 according to the specifications in Exhibit J, and as marked in the field.

Construct sediment catch basins as shown in Exhibit K at the following locations, and as marked in the field: 10+65, 10+75, 11+35, and 12+20 (2).

Construct a culvert catch basin 8' wide x 8' long x 4' deep with 1 1/2:1 side slopes at Station 118+50, as marked in the field.

Construct variable depth ditches with 1 1/2:1 side slopes adjacent to culverts at Stations 125+05 and 126+90 to eliminate standing water, as marked in the field.

EXHIBIT "B"

ADDITIONAL INSTRUCTIONS

**C to D**  
**Cont.**

Line ditchlines with 9" depth of rock between the following Stations according to the specifications in Exhibit C, and as marked in the field: 10+25 to 11+50, and 11+90 to 13+30.

Line fill slopes with 9" depth of rock between the following Stations according to the specifications in Exhibit C, and as marked in the field: 11+00 to 11+50, and 11+90 to 12+40.

Repair fill slope at outlet of existing culvert at Station 34+35 according to the specification in Exhibits B and C, as marked in the field.

Block access to the left at Station 10+75 according to Exhibit C, and as marked in the field.

Block access to the right at the following Stations according to Exhibit C, and as marked in the field: 9+00, 10+75, and 14+40.

Stabilize road prism by placing riprap at the toe of the left fill slope between the following Stations according to Exhibits B, C and L, and as marked in the field: 36+30 to 36+70, and 124+40 to 125+60.

**E to F**

Remove berm between roadway and fill slope to subgrade elevation and outslope at least 4 to 6 percent between Stations 7+65 and 15+70. Excavated material shall be scattered outside of right-of-way.

Raise subgrade elevation to establish a constant road grade between the existing subgrade elevations of Stations 4+60 and 5+10, and 7+00 and 7+65.

Construct 3 waterbars on spur road to the left of Station 15+25 according to the specifications in Exhibit F, and as marked in the field.

**E to G**

Remove berm between roadway and fill slope to subgrade elevation and outslope at least 4 to 6 percent between Stations 9+90 and 10+20. Excavated material shall be scattered outside of right-of-way.

Remove berm between roadway and fill slope to subgrade elevation and outslope at least 4 to 6 percent between the following Stations: 1+40 to 9+90, and 27+10 to 31+85.

Widen road subgrade 5 feet to the left to improve alignment between Stations 2+35 and 3+50.

Improve the road between Stations 31+45 and 33+25 using a horizontal curve radius of 50 feet as marked in the field.

Construct a culvert catch basin 15' wide x 15' long x 4' deep with 1 1/2:1 side slopes at Station 0+50 and remove logs and debris from channel above culvert catch basin, as marked in the field.

Remove buried logs from subgrade between Stations 4+35 and 4+65 and place logs perpendicular to roadway outside of right-of-way.

EXHIBIT "B"  
ROAD BRUSHING SPECIFICATIONS



Clearing Limits

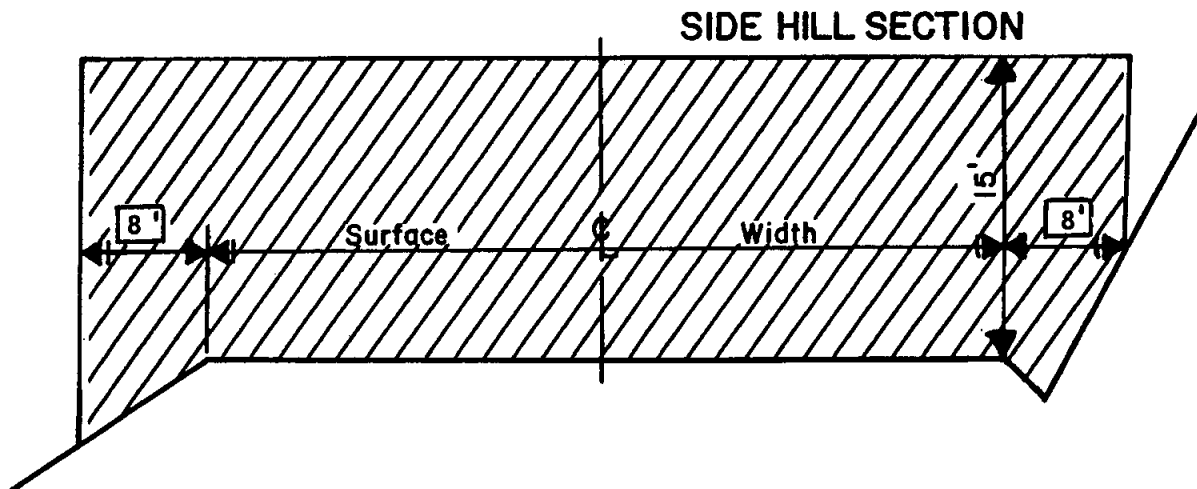

REQUIREMENTS

Brush and trees shall be cut to a height of 6 inches or less above the ground surface or obstructions such as rocks or existing stumps.

Debris resulting from the brushing operation shall be removed from the roadway, cutslope, ditches, and water courses within 72 hours and may be scattered downslope from the road or placed in other stable locations, unless otherwise approved in writing by STATE. Trees outside the clearing limits shall not be felled, unless approved in writing by STATE.

EXHIBIT "B"

END-HAULING REQUIREMENTS

POINT TO POINT	STA. TO STA.	WASTE AREA LOCATION	WASTE AREA TREATMENT
A to B	2+00 to 3+00	2	2
C to D	5+50 to 9+00	1	1
C to D	11+90 to 13+50	1	1
C to D	29+00 to 32+50	1	1
C to D	32+50 to 33+75	1, 3, 4, 5	1, 3
C to D	33+75 to 143+15	1	1
E to F	0+00 to 15+70	6	2
E to F	5+10 to 7+00	7	2
E to F	7+65 to 8+80	8	2
E to G	0+00 to 10+20	1	1
E to G	10+20 to 27+10	1, 9	1, 2
E to G	27+10 to 31+85	1	1

End-Haul Areas General Requirements

Material shall not be intentionally side cast.

Clearing and grubbing debris shall be end-hauled.

When blasting is required, it shall be accomplished using timing devices, delayed charges, low intensity shots, or other suitable means to contain as much material as possible within the road prism.

Containment

Full containment: The amount of material lost over the outside edge of the road shall not exceed 6 inches in depth measured perpendicular to the natural ground slope. Pioneer excavation shall be removed by digging, loading, and hauling rather than by pushing or scraping methods.

Trees and stumps may have up to 12 inches of material directly above them. Any amount of material exceeding the containment requirements shall be removed by whatever means necessary and end-hauled to a designated waste area.

Waste Area Locations

- (1) As shown on Exhibit A and as marked in the field.
- (2) Points A to B, Station 2+00 to 3+00
- (3) Points C to D, Station 10+25 to 11+50
- (4) Points C to D, Station 11+90 to 13+30
- (5) Points C to D, Station 34+35
- (6) Points E to F, Station 0+00 to 15+70
- (7) Points E to F, Station 4+60 to 5+10
- (8) Points E to F, Station 7+00 to 7+65
- (9) Points E to G, Station 10+20 to 27+10

Waste Area Treatment

- (1) Deposit at waste area, spread evenly, compact, and provide adequate drainage. Pile woody debris separate from other waste material.
- (2) Suitable material may be used for fill construction.
- (3) Suitable rock that meets pit-run specifications in Exhibit C is to be used for ditchlines, fills, and road rock.

EXHIBIT "C"  
 ROAD SURFACING

TYPE OF ROCK	SIZE OF ROCK	COMPACTED DEPTH	POINT TO POINT	STATION TO STATION	APPROX. TOTAL TRUCK MEASURE VOLUME
Pit-Run	---	9 "	A to B	0+00 to 63+50	3334 CY
Crushed	2½"-0"	8 "	C to D	0+00 to 153+90	7110 CY
Pit-Run	---	12 "	E to F	0+00 to 15+70	1104 CY
Pit-Run	---	9 "	E to G	0+00 to 47+10	2473 CY
Crushed	2½"-0"	4 "	E to G	0+00 to 32+00	* 739 CY
Pit-Run	---	12 "	H to I	0+00 to 3+40	239 CY
<b>TURNOUTS:</b>			<b>NO. OF T.O.</b>	<b>LOCATIONS</b>	
Pit-Run	---	9 "	8	A to B	136 CY
Crushed	2½"-0"	8 "	22	C to D	330 CY
Pit-Run	---	12 "	3	E to F	66 CY
Pit-Run	---	9 "	9	E to G	153 CY
Crushed	2½"-0"	4 "	8	E to G	* 56 CY
Pit-Run	---	12 "	1	H to I	22 CY
<b>TURNAROUNDS:</b>			<b>NO. OF T.A.</b>		
Pit-Run	---	9 "	3	A to B Sta. 19+80, 38+90, 62+50	51 CY
Crushed	2½"-0"	8 "	2	C to D Sta. 134+50 & 146+50	30 CY
Pit-Run	---	12 "	1	E to F Sta. 15+20	22 CY
Pit-Run	---	9 "	2	E to G Sta. 43+30 & 47+10	34 CY
Pit-Run	---	12 "	1	H to I Sta. 3+40	22 CY
<b>JUNCTIONS:</b>			<b>NO. OF JCTS.</b>		
Pit-Run	---	9 "	1	A to B Sta. 0+00	50 CY
Pit-Run	---	9 "	1	A to B Sta. 2+25	50 CY
Pit-Run	---	9 "	1	A to B Sta. 38+90	50 CY
Crushed	2½"-0"	8 "	1	C to D Sta. 0+00	40 CY
Crushed	2½"-0"	8 "	1	C to D Sta. 87+00	15 CY
Crushed	2½"-0"	8 "	1	C to D Sta. 93+70	40 CY
Pit-Run	---	12 "	1	E to F Sta. 0+00	30 CY
Pit-Run	---	9 "	1	E to G Sta. 0+00	30 CY
Crushed	2½"-0"	4 "	1	E to G Sta. 0+00	* 15 CY
Pit-Run	---	9 "	1	E to G Sta. 31+85	40 CY
Crushed	2½"-0"	4 "	1	E to G Sta. 31+85	* 15 CY
Pit-Run	---	12 "	1	H to I Sta. 0+00	50 CY
<b>STOCKPILE</b>			<b>DESCRIPTION</b>		
Crushed	2½"-0"	---	Stockpile	**	1998 CY

EXHIBIT "C"  
 ROAD SURFACING

TYPE OF ROCK MISCELLANEOUS:	SIZE OF ROCK	USE	POINT TO POINT	STATION TO STATION	APPROX. TOTAL TRUCK MEASURE VOLUME
Riprap	48"-24"	Block Access	C to D	9+00	50 CY
Riprap	48"-24"	Block Access	C to D	10+75	30 CY
Riprap	48"-24"	Block Access	C to D	14+40	30 CY
Riprap	48"-24"	Stabilization	C to D	36+30 to 36+70	70 CY
Riprap	48"-24"	Armor Inlet	C to D	36+80	5 CY
Riprap	48"-24"	Armor Inlet	C to D	36+84	10 CY
Riprap	48"-24"	Energy Dissipater	C to D	67+00	30 CY
Riprap	48"-24"	Energy Dissipater	C to D	73+00	30 CY
Riprap	48"-24"	Energy Dissipater	C to D	85+55	10 CY
Riprap	48"-24"	Energy Dissipater	C to D	118+50	20 CY
Riprap	48"-24"	Energy Dissipater	C to D	119+75	40 CY
Riprap	48"-24"	Stabilization	C to D	124+40 to 125+60	335 CY
Riprap	48"-24"	Energy Dissipater	C to D	125+05	70 CY
Riprap	48"-24"	Energy Dissipater	C to D	130+60	80 CY
Riprap	48"-24"	Energy Dissipater	C to D	131+65	30 CY
Pit-Run	---	Armor Ditchline	C to D	10+25 to 11+50	30 CY
Pit-Run	---	Armor Fill Slope	C to D	11+00 to 11+50	35 CY
Pit-Run	---	Armor Ditchline	C to D	11+90 to 13+30	35 CY
Pit-Run	---	Armor Fill Slope	C to D	11+90 to 12+40	40 CY
Pit-Run	---	Fill	C to D	34+35	15 CY

\*Obtain approval from STATE for pit-run rock prior to spreading crushed rock.

\*\*Shown on Exhibit A and as marked in the field.

Additional rock for curve widening is required and has been included in the volume estimates.

Roads shall be uniformly graded and approved by STATE prior to rocking. For typical cross section, see Forestry Department Drawing Nos. 351-C and 351-D at the Forestry Department district office.

Waterbars specified in Exhibit B shall be constructed after rock has been compacted.

Turnouts, turnarounds, and junctions shall be rocked concurrently with road.

End-dumping of riprap shall not be allowed, unless approved in writing by STATE.



EXHIBIT "C"

CRUSHED ROCK SPECIFICATIONS

Materials. The material shall be fragments of rock or other hard, durable particles crushed to the required size and a filler of finely crushed stone, sand, or other finely divided mineral matter. The material shall be free from vegetation and lumps of clay.

Quality and Grading Requirements. The stone base materials shall be crushed rock, including sand. River gravel shall not be used.

The material from which base material is produced or manufactured shall conform to the general requirements of Section 2630 of the "Standard Specifications for Highway Construction" prepared by the Highway Division, Oregon Department of Transportation, and shall meet the following test requirements:

Hardness - Test Method AASHTO T 96 35% Maximum

Durability - Test Method ODOT TM 208  
Passing No. 20 Sieve: 30% Maximum  
Sediment Height: 3" Maximum

The rock crusher shall be calibrated to produce rock as specified in Exhibit C. Prior to the commencement of production crushing, PURCHASER shall sample, test, and provide rock test results meeting STATE specifications. STATE may then sample and test crushed rock for approval to proceed. PURCHASER shall take one sample of each 1,000 cubic yards of crushed rock material produced thereafter, using approved AASHTO sampling procedures. PURCHASER shall submit samples to a certified laboratory or shall perform testing for gradation requirements using AASHTO T 11 and AASHTO T 27 testing procedures. Prior to testing, each sample shall be split, making one-half of the sample, with proper identification, available for testing by STATE. Each sample and the results of PURCHASER testing shall be made available to STATE within 24 hours of sampling. Any rock crushed prior to STATE approval to proceed shall not be credited to the required rock quantity. Any subsequent rock tests not meeting STATE specifications shall be reason for rejection of that portion of crushed rock produced after that test and shall not be credited to the required rock quantity. STATE may sample the crushed rock at any time during the operation. Results of STATE's tests shall prevail over all other test results.

<u>For 2½"-0"</u>	Passing	3" sieve	100%
	Passing	2½" sieve	95-100%
	Passing	1¼" sieve	50-70%
	Passing	1/4" sieve	20-40%

Of the fraction passing 1/4" sieve, 40% to 60% shall pass the No. 10 sieve.

<u>For Pit-Run</u>	Passing	10" sieve	100%
	Passing	6" sieve	60-80%
	Passing	3" sieve	30-50%

For 48"-24" Riprap 50 percent of the rock shall be at least 1 cubic yard or more in volume. 100% of the rock shall be at least 4 cubic feet in volume.

Control of gradation of riprap and pit-run shall be by visual inspection by STATE.

The referenced sieve shall have square openings as set forth in AASHTO M 92, Woven Cloth Series. The determinations of size and gradings shall be as set forth in AASHTO T 27.

EXHIBIT "C"

ROCK ACCOUNTABILITY

The rock shall meet the quality and size specifications in Exhibit C. A sample of the rock shall be supplied to STATE for testing and approval prior to rocking. PURCHASER shall obtain subgrade approval from STATE prior to rocking. Rocking shall be limited to periods when weather conditions are acceptable to STATE and when sediments will not enter streams.

Rock accountability shall be determined by depth measurement. STATE shall be given 24 hours' notice prior to rocking.

Depth Measurement. Road rock shall be spread and compacted according to the depths specified in Exhibit C. Truck measure volumes are given, but shall not limit the amount of rock spread.

Depth shall be determined in the most compacted area of the surface cross section. If additional rock is required because of insufficient depth, it shall be added by truck measure to those areas that were slighted. The conversion from compacted yardage to truck yardage is 1.3 multiplied by the compacted yardage equals truck yardage.

The depth of compacted aggregates shall not vary more than 1 inch from the depth specified in Exhibit C. The average depth for each road segment shall be the specified depth or greater.

Junctions shall have a surfaced area as marked in the field at the compacted depths specified in Exhibit C.

Turnouts shall have a surfaced area of at least 44 square yards each at the depths shown in Exhibit C.

Turnarounds shall have a surfaced area of at least 44 square yards each at the depths shown in Exhibit C.

Curve Surfacing. Extra surface width shall be required for the inside of all curves as follows: 400 divided by the radius of the curve equals the amount of extra width to be surfaced at the depths shown in Exhibit C.

EXHIBIT "C"

COMPACTION AND PROCESSING REQUIREMENTS

**Subgrade.** Subgrade surfaces of the road segments listed below shall be graded and compacted prior to rocking. Compaction shall be accomplished by traveling all surfaces from shoulder to shoulder until visible deformation ceases, or in the case of a sheepsfoot roller, the roller "walks out." At least 3 passes shall be made over the entire width and length of the road. A pass is defined as traveling a road section in one direction and then back over that same section again. Compaction shall be accomplished by using the approved equipment listed below or others approved by STATE:

ROAD SEGMENT	COMPACTION EQUIPMENT OPTIONS
All	Vibratory Roller

**Fills.** Embankments and fills shall be placed in (approximately) horizontal layers not more than 8 inches in depth. Each layer shall be separately, and thoroughly, compacted. Compaction equipment shall be operated over the entire width of each layer until visible deformation of the layers ceases or, in the case of a sheepsfoot roller, the roller "walks out." At least of 3 passes shall be made over the entire width and length of each layer. A pass is defined as traveling a fill layer in one direction and then back over that same layer again.

Placing individual rocks or boulders with more depth than the allowed layer thickness shall be permitted, provided the embankment will accommodate them. Such rocks and boulders shall be at least 6 inches below the subgrade. They shall be carefully distributed and the voids filled with finer material, forming a dense and compacted mass. Compaction shall be accomplished by using the approved equipment listed below or others approved by STATE:

ROAD SEGMENT	COMPACTION EQUIPMENT OPTIONS
All	Crawler Tractor and Tamping Foot Compactor

**Pit-Run Rock.** Pit-run surfacing rock shall be spread on roads with a crawler tractor and continuously walked-in. Rock spreading shall begin at nearest point from the rock source and progress toward the end of the project, unless otherwise approved in writing by STATE. Compaction shall be accomplished by using the approved equipment listed below or others approved by STATE:

Rock shall be compacted and processed during the same project period it is spread, unless otherwise approved in writing by STATE.

Rock shall be crowned or outsloped at 4 to 6 percent as specified in "Forest Road Specifications" in Exhibit B.

ROAD SEGMENT	COMPACTION EQUIPMENT OPTIONS
All	Vibratory Grid Compactor

EXHIBIT "C"

COMPACTION AND PROCESSING REQUIREMENTS

**Crushed Rock.** The rock shall be uniformly mixed and spread in layers on the approved roadbed. Each layer of crushed rock shall be moistened or dried to a uniform moisture content suitable for maximum compaction and compacted in layers not to exceed 6 inches in depth. When more than 1 layer is required, each shall be shaped and compacted before the succeeding layer is placed. Any irregularities or depressions that develop during compaction of the top layer shall be corrected by loosening the material at these places and adding or removing material until the surface is smooth and uniform. Each layer shall be compacted with at least 3 passes over the entire width and length of the road. A pass is defined as traveling a road section in one direction and then back over that same section again. Compaction shall be accomplished by using the approved equipment listed below or others approved by STATE:

Rock shall be compacted and processed during the same project period it is spread, unless otherwise approved in writing by STATE.

Rock shall be crowned or outsloped at 4 to 6 percent as specified in "Forest Road Specifications" in Exhibit B.

ROAD SEGMENT	COMPACTION EQUIPMENT OPTIONS
All	Vibratory Roller

COMPACTION EQUIPMENT OPTIONS

**Vibratory Rollers.** The drum shall have a smooth surface, a diameter not less than 48 inches, a width not less than 58 inches, and a turning radius of 15 feet or less. Vibration frequency shall be regulated in steps to 1400, 1500, and 1600 VPM, corresponding to engine speeds of 1575, 1690, and 1800 RPM. The centrifugal force developed shall be 7 tons at 1600 VPM. It shall be activated by a power unit of not less than 25 horsepower. The vibratory roller shall be self-propelled and operated at speeds ranging from 0.9 mile to 1.8 miles per hour, as directed by STATE.

**Tampingfoot Compactors.** Tampingfoot or sheepsfoot compactors shall exert a minimum pressure of 250 pounds per square inch on the ground area in contact with the tamping feet. The compactor shall cover a minimum width of 60 inches per pass and weigh a minimum of 16,000 pounds.

**Vibratory Grid Compactors.** The roller shall have a grid surface and have an operating weight of 32,000 pounds or more. The rock shall be worked with a grader weighing at least 20,000 pounds during the grid rolling process.

All rock shall come in contact with the vibratory grid compactor. A minimum of 10 passes shall be made with the grader and vibratory grid compactor over the entire length of the road, unless STATE requires fewer passes.

**Crawler Tractors.** D-7 Caterpillar or equivalent or larger.

EXHIBIT "D"

ROCK PIT DEVELOPMENT AND USE

- (1) PURCHASER shall conduct the operations relative to the disposal of waste material in such manner that silt, rock, debris, dirt, or clay shall not be washed, conveyed, or otherwise deposited in any stream. All waste shall be deposited at an approved "waste disposal site."
- (2) Where overburden removal limits have not been staked, they shall extend for a distance of at least 20 feet beyond the developed rock source. Overburden and woody debris shall be hauled to a designated waste area. Overburden shall be spread evenly, grass seeded, and compacted at the waste area and woody debris stacked separately. Prior to drilling or rock removal, completion of overburden removal shall be approved in writing by STATE.
- (3) The rock pit floor shall be developed to provide drainage away from the rock pit. Rock pit drainage ditches shall be developed and maintained. Benches shall be constructed at intervals of 40 feet or less in height and shall be a minimum of 20 feet in width. Any gravel or talus slopes shall be left with a working face at an angle of 60 degrees or less. There shall be a minimum of 1 bench with an access road to it. Said bench shall be easily accessible with tractors.
- (4) Blasting shall be accomplished using timing devices, delay charges, low intensity shots, or other suitable means to contain as much material as possible in the rock pit prism.
- (5) Pit face shall be developed in a uniform manner.
- (6) Oversized material that is produced or encountered during development shall be broken down and utilized for crushing.
- (7) PURCHASER shall prepare a written development plan for the pit area. The plan shall be submitted to STATE for approval prior to conducting any operation in the pit area.

The plan shall include, but not be limited to:

- (a) Location of benches and roads to benches.
  - (b) Disposal site for debris and overburden.
- (8) Upon completion of use, the pit site and access roads shall be left in a condition free from overburden and debris. Rock pit roads shall be waterbarred to provide drainage as specified in Exhibit F and be blocked as directed by STATE.

EXHIBIT "E"

CULVERT SPECIFICATIONS

All culvert materials shall be furnished and installed by PURCHASER, unless otherwise specified in the contract. Culverts shall be constructed of corrugated aluminized steel. Corrugated polyethylene culverts may be used for sizes up to 36 inches in diameter. All culverts shall conform to the material and fabricating requirements of Sections 2410 or 2420 of the "Standard Specifications for Highway Construction" prepared by the Highway Division of the Oregon State Department of Transportation. Corrugation types and shapes other than those meeting the above minimum Highway requirements, shall be approved in writing by STATE.

Culverts shall be located according to the alignment and grade as shown on the Plan and Profile, and/or as staked in the field, or as stipulated in special instructions.

The STATE Representative shall determine final culvert locations and stake the locations in the field prior to installation.

Culvert grade shall slope away from ditch grade at least 2 percent unless otherwise specified.

Culverts less than 36 inches in diameter shall be installed with the lock seam on the inlet end placed within 30 to 60 degrees from the bottom of the trench, measured counter-clockwise, facing the inlet.

The foundation and trench walls for all culverts shall be free from logs, stumps, limbs, stones, and other objects which would dent or damage the pipe. The culvert trench shall be excavated 3 pipe diameters wide to permit compaction and working on each side of the pipe. Tamping shall be done in 6-inch lifts, 1 pipe diameter each side of the pipe to 95 percent density or over. Bedrock shall be excavated as required to provide a uniform foundation for the full length of the culvert.

A bedding of granulated material or crushed rock as specified shall be placed to provide a wide band of support and to transmit the load from above evenly over the entire length of the pipe.

Backfill shall consist of granulated material, crushed rock, or job-excavated soil free of stumps, limbs, rocks, or other objects which would damage the pipe.

Transporting of the pipe shall be done carefully. Dragging or allowing free fall from trucks or into trenches shall not be permitted.

Joining shall be done with bands of like material and corrugations. Manufacturers' instructions shall be followed for prefabricated pipe assembly.

Polyethylene joints shall be made with split couplings, corrugated to engage the pipe corrugations, and shall engage a minimum of 4 corrugations, 2 on each side of the pipe joint.

A manufacturer's certification that the product was manufactured, tested, and supplied in accordance with this specification shall be furnished to the Project Engineer upon request.

EXHIBIT "E"

CULVERT SPECIFICATIONS

Minimum height of cover over top of culvert to subgrade when road is to be rocked shall be as follows: 12" for culverts 18" to 24" (add 6" for roads which will not be rocked). Minimum vertical cover for other designs shall be as specified by STATE.

Lengths of individual culvert sections shall be not less than 10 feet, unless otherwise provided for in special instructions.

The ends of each culvert shall be free of logs and debris which would restrict the free flow of water. The intake end of relief culverts shall be provided with a sediment catching basin 3 feet in diameter at the bottom. The outlet end of any culvert which would allow water to erode embankment soil shall be provided with a half round or other approved slope protection device. Construct the lead-off ditch away from the culvert outlet where the slope gradient restricts the free flow of water.

Following are the minimum standard gauges for pipe and coupling bands.

<u>Dia.</u>	<u>Steel Pipe Gauge or Aluminized</u>	<u>Band Gauges</u>	<u>Band Widths ("</u>			<u>Hugger Band Widths ("</u>	
			<u>Annular</u>	<u>Helical</u>	<u>Dimpled</u>	<u>Annular</u>	<u>Helical</u>
18-30	16	16	12	12	12	13 1/8	10 1/2

EXHIBIT "E"  
 CULVERT LIST

CULVERT NO.	DIAMETER (Inches)	LENGTH (Feet)	ROAD SEGMENT POINT TO POINT	STATION
1	18	36	C to D	3+40
2	18	32	C to D	10+75
3	18	30	C to D	13+30
4	18	30	C to D	22+30
5	24	36	C to D	26+75
6	18	36	C to D	27+45
Half Round	21	10	C to D	27+45
7	18	28	C to D	38+50
Half Round	21	20	C to D	38+50
8	18	26	C to D	46+40
Half Round	21	20	C to D	46+40
Half Round	21	20	C to D	49+40
9	18	28	C to D	52+80
Half Round	21	20	C to D	52+80
10	18	36	C to D	55+60
Half Round	21	20	C to D	55+60
11	18	34	C to D	58+60
Half Round	21	20	C to D	58+60
12	18	28	C to D	62+30
Half Round	21	20	C to D	62+30
13	18	28	C to D	64+50
Half Round	21	20	C to D	64+50
14	18	28	C to D	70+30
Half Round	21	20	C to D	70+30
15	18	30	C to D	78+10
Half Round	21	10	C to D	78+10
16	18	34	C to D	89+30
17	24	28	C to D	94+80
Half Round	30	10	C to D	94+80
18	24	30	C to D	98+10
19	18	26	C to D	102+10
Half Round	21	20	C to D	102+10
20	18	32	C to D	108+30
Half Round	21	20	C to D	108+30
21	18	28	C to D	115+80
Half Round	21	20	C to D	115+80
22	24	36	C to D	118+50
23	24	30	C to D	119+75
24	18	26	C to D	120+50
Half Round	21	20	C to D	120+50
25	24	24	C to D	125+05



EXHIBIT "E"  
 CULVERT LIST

CULVERT NO.	DIAMETER (Inches)	LENGTH (Feet)	ROAD SEGMENT POINT TO POINT	STATION
26	18	28	C to D	126+90
Half Round	21	20	C to D	126+90
27	18	28	C to D	128+40
Half Round	21	20	C to D	128+40
28	24	30	C to D	130+60
29	18	28	C to D	131+65
30	18	28	C to D	133+60
Half Round	21	20	C to D	133+60
31	18	30	C to D	135+55
Half Round	21	20	C to D	135+55
32	18	30	C to D	139+55
Half Round	21	10	C to D	139+55
33	18	36	C to D	144+30
34	24	30	C to D	151+05
Half Round	30	10	C to D	151+05
35	18	40	E to F	4+80
36	18	66	E to G	0+50
37	18	26	E to G	3+50
Half Round	21	20	E to G	3+50
38	18	42	E to G	5+75
Half Round	21	10	E to G	5+75
39	18	36	E to G	9+90
40	18	30	E to G	13+50
Half Round	21	10	E to G	13+50
41	18	26	E to G	16+50
42	18	28	E to G	20+40
Half Round	21	20	E to G	20+40
43	18	32	E to G	24+30
Half Round	21	10	E to G	24+30
44	18	28	E to G	28+35
Half Round	21	20	E to G	28+35

The intake ends of culverts shall be marked as specified in Exhibit E, page 6.

Tamping is required on all culverts.

All metal culverts scheduled for replacement shall become property of PURCHASER and be removed from STATE land in the same project period in which replacement occurred.

Half rounds shall be installed within 72 hours of culvert installation, unless otherwise approved in writing by STATE. Steel posts used with half-round installation shall be painted with rust preventative paint.

EXHIBIT "E"

TYPICAL HALF ROUND CULVERT INSTALLATION

(no scale)

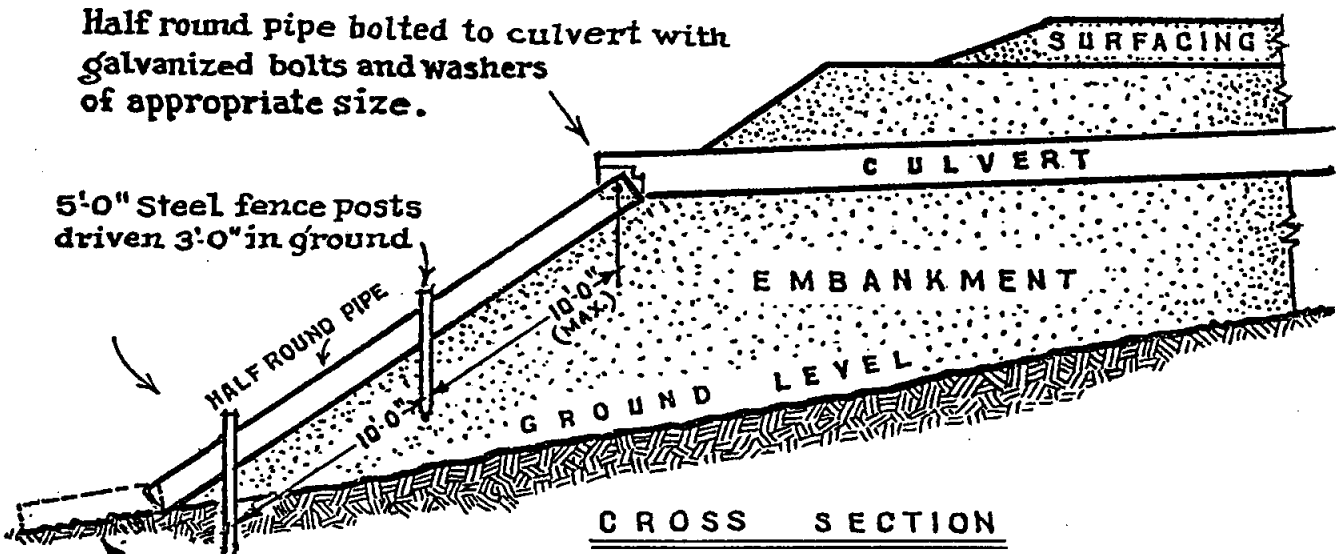

Solid rock, boulders etc.  
If erodable, install half  
round not less than  
5.0ft. as directed  
by state.

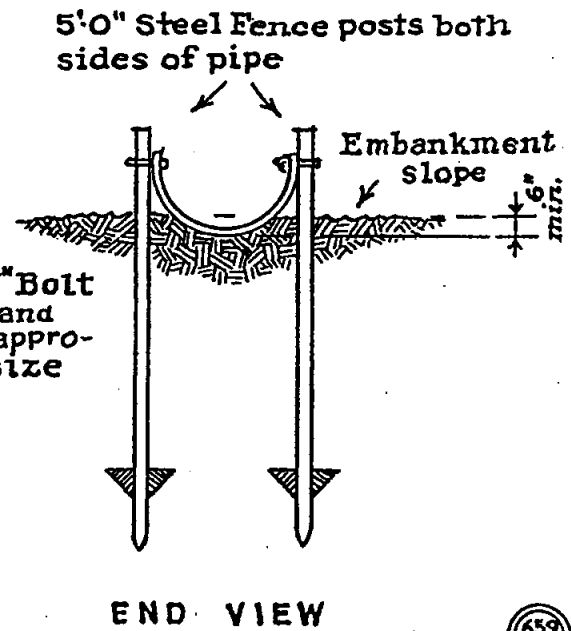
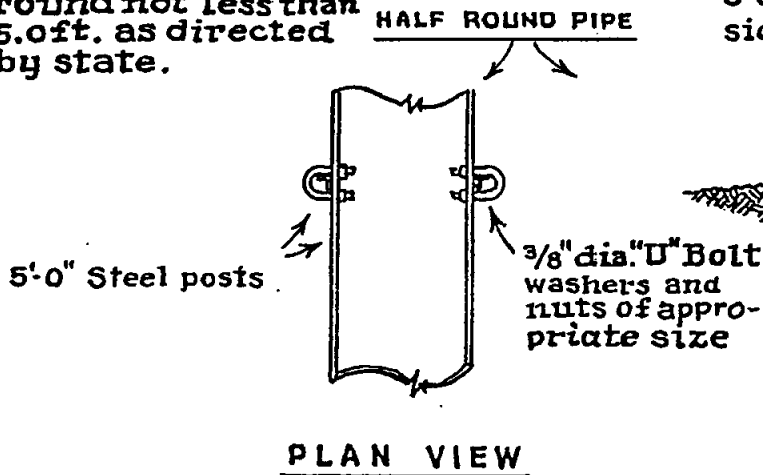

EXHIBIT "E"  
CULVERT MARKER SPECIFICATIONS

Culverts shall be marked in the same project period in which culvert installation occurs.

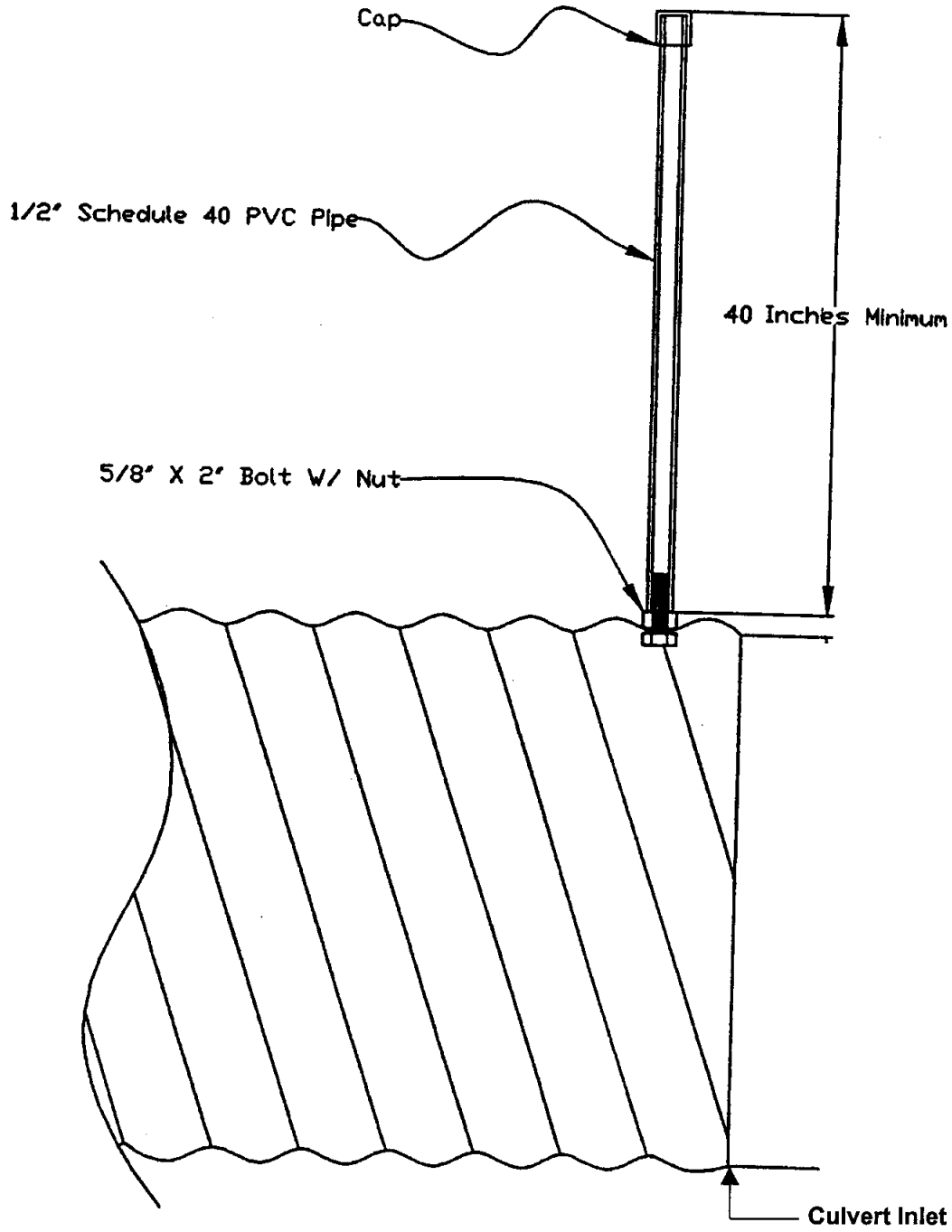

EXHIBIT "E"  
TYPICAL EMBEDDED ENERGY DISSIPATOR

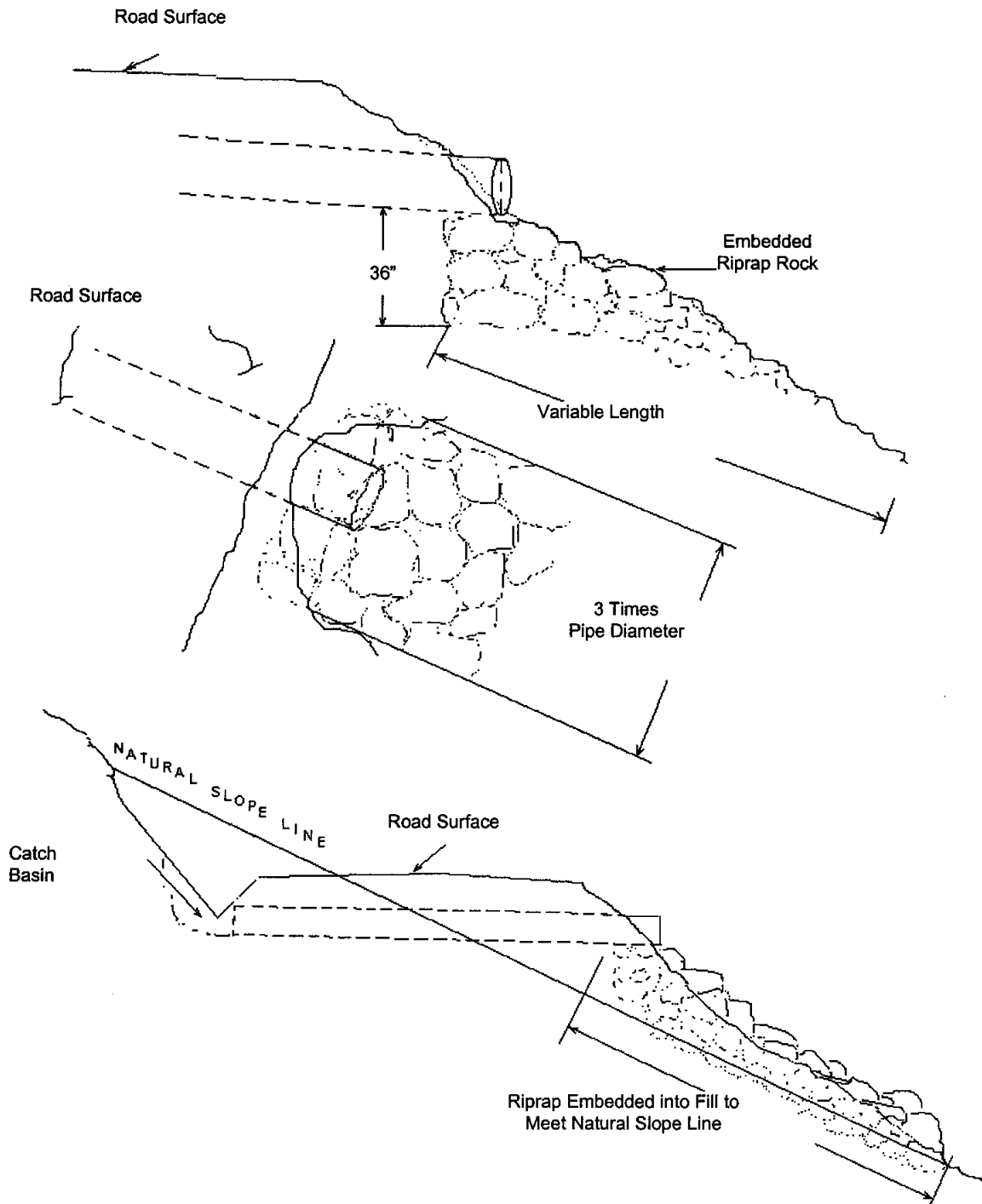
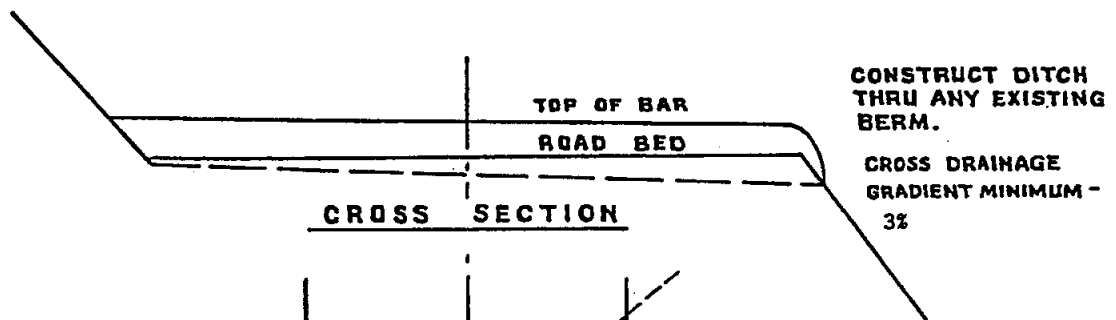
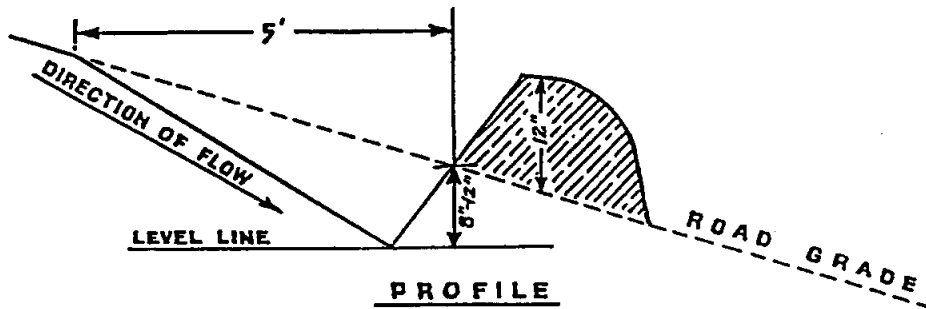

EXHIBIT "F"

WATERBAR SPECIFICATIONS



**SPACING OF WATERBARS**

ROAD GRADE	DISTANCE
≤ 5%	600'
6-10%	300'
11-15%	150'
16-20% or greater	100'

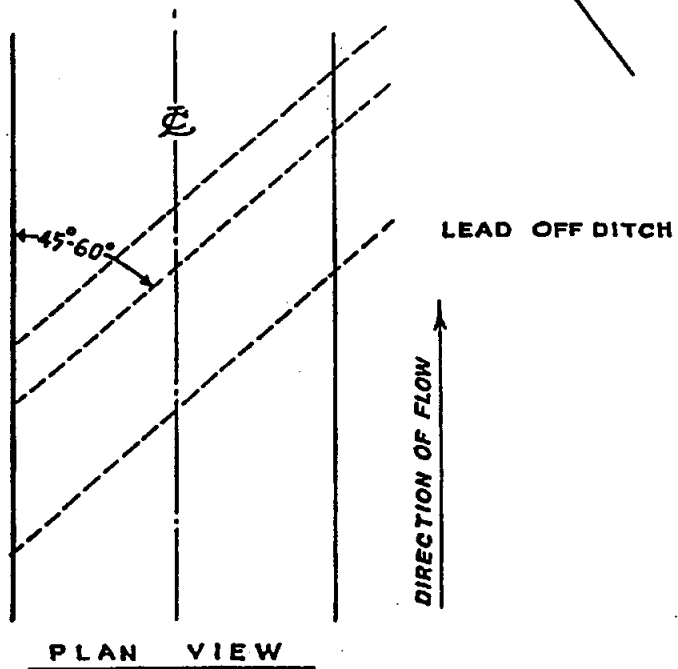

WATERBAR SPECIFICATIONS  
 FOR CROSS DITCHING #298

EXHIBIT "G"

TYPICAL CROSS SECTION VIEW OF SIDECAST PULLBACK AND ROAD REALIGNMENT

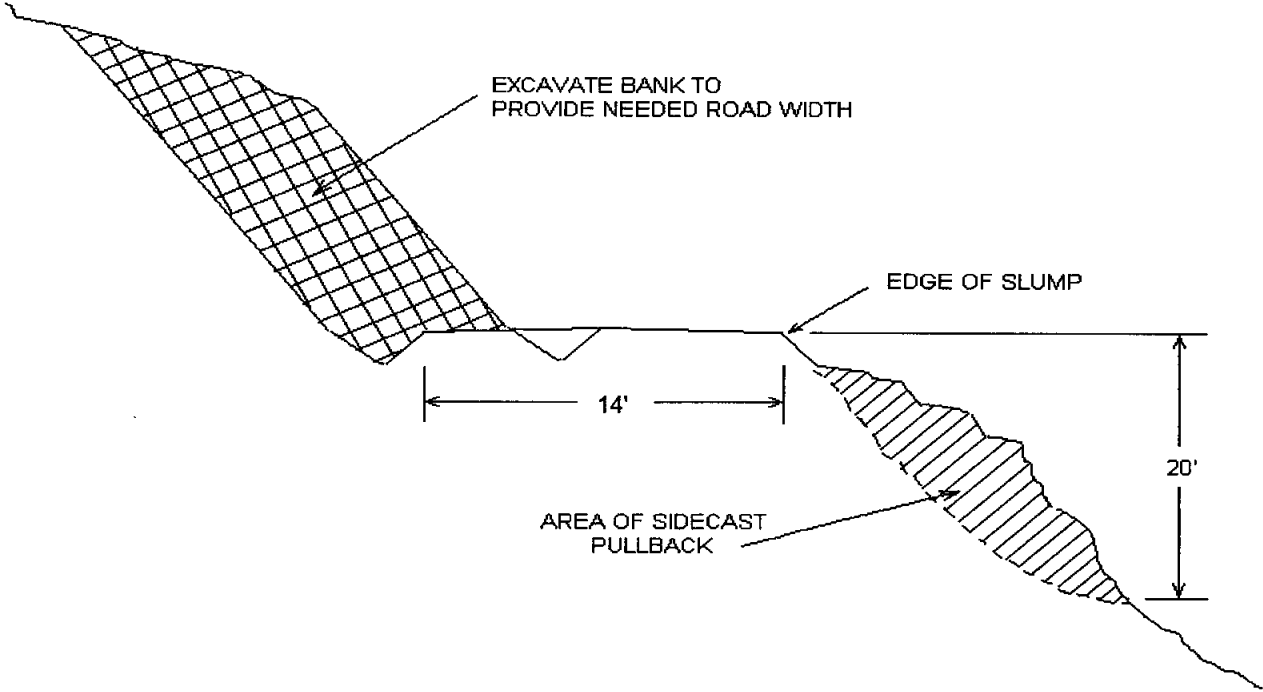

(No Scale)

State Timber Sale Contract  
No. 341-03-86  
Cook East

EXHIBIT "H"

SEEDING AND FERTILIZING

This work shall consist of preparing seedbeds and furnishing and placing required seed and fertilizer.

Seeding Seasons. Seeding shall be performed only from March 1 through June 15 and August 15 through October 31. Seeding materials shall not be applied during windy weather or when the ground is excessively wet or frozen. Areas of disturbed soil shall be seeded by the end of the project period in which work was started. PURCHASER shall notify STATE 24 hours prior to seeding.

Soil Preparation. Areas to be seeded that have been damaged by erosion or other causes shall be restored prior to seeding. All areas to be seeded shall be finished and then cultivated to provide a reasonably firm, but friable seedbed. A minimum of 1/2 inch of surface soil shall be in a loose condition.

Application Methods for Seed and Fertilizer

Dry Method. Mechanical seeders, seed drills, landscape seeders, cultipacker seeders, fertilizer spreaders, or other approved mechanical seeding equipment shall be used to apply the seed and fertilizer in the amounts and mixtures specified. Hand-operated seeding devices may be used when seed and fertilizer are applied in dry form.

Application Rates for Seed and Fertilizer

Seed listed below shall be applied at the following rates per acre:

SPECIES	LB./ACRE	MIXTURE	PURE LIVE SEED	POISON AND/OR REPELLENT
Fine Fescue	12	40%	98%	0
Annual Ryegrass	6	20%	98%	0
Perennial Ryegrass	9	30%	98%	0
White Dutch Clover	3	10%	98%	0

Fertilizer: Chemical analysis shall be 16-20-0 and shall be applied at the rate of 300 pounds per acre.

State Timber Sale Contract  
No. 341-03-86  
Cook East

EXHIBIT "I"

MULCHING

This work shall consist of furnishing and placing required mulch. Mulch shall consist of straw that is free of noxious weeds.

Mulching Period. Straw mulch shall be applied within 24 hours of spreading grass seed and fertilizer.

Application Rates for Mulch

Place straw mulch to a reasonably uniform thickness of 1½ to 2½ inches. This rate requires between 2 and 3 tons of dry mulch per acre.



EXHIBIT "J"  
 VERTICAL ROAD DIP  
 (Not to Scale)

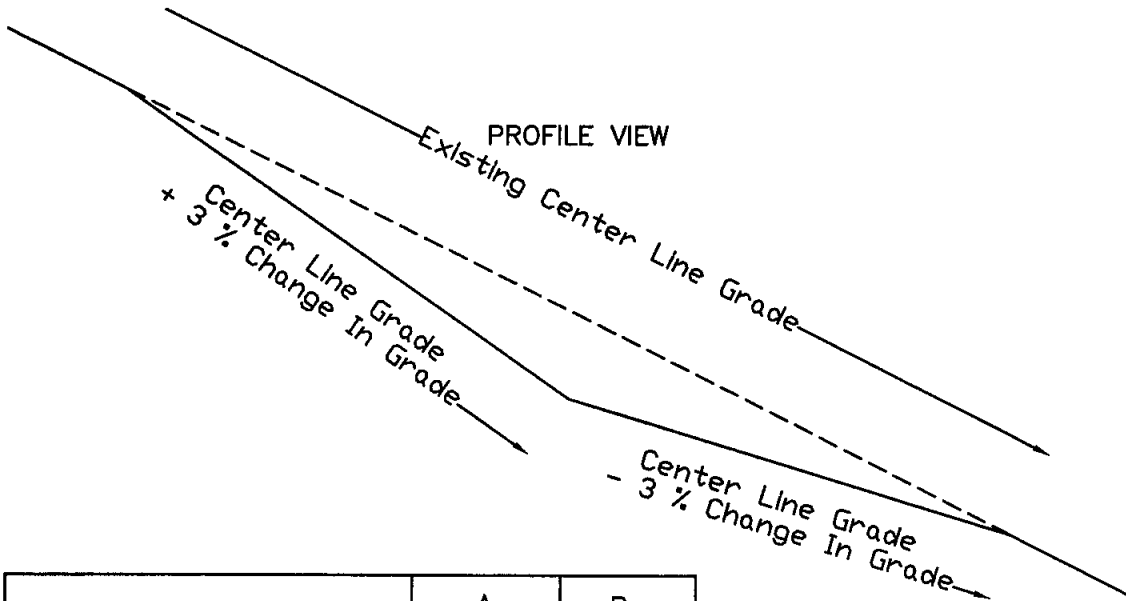
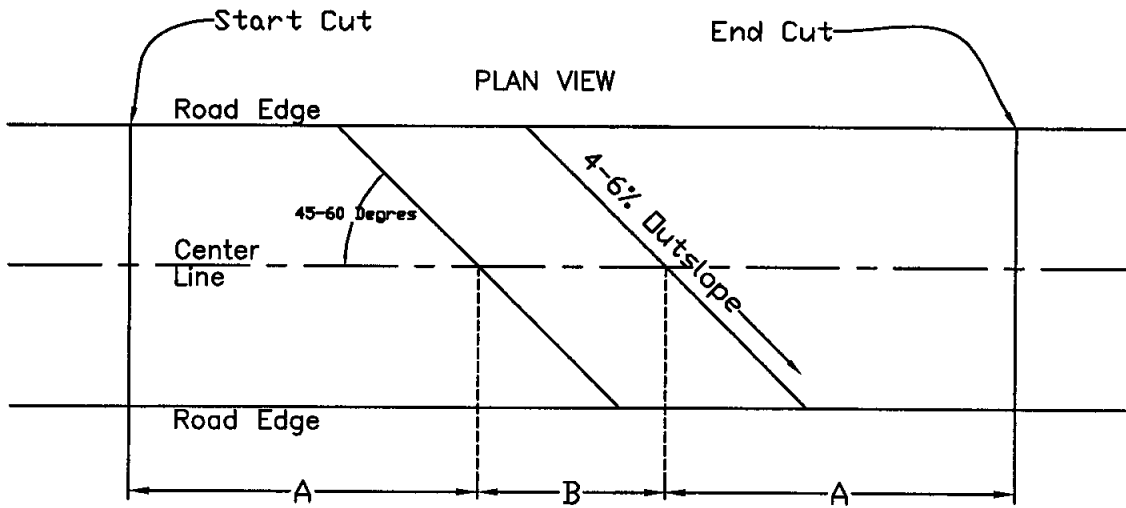

STATION	A	B
10+25 to 11+50	50 feet	25 feet

State Timber Sale Contract  
No. 341-03-86  
Cook East

EXHIBIT "K"  
SEDIMENT CATCH BASIN (Typical)

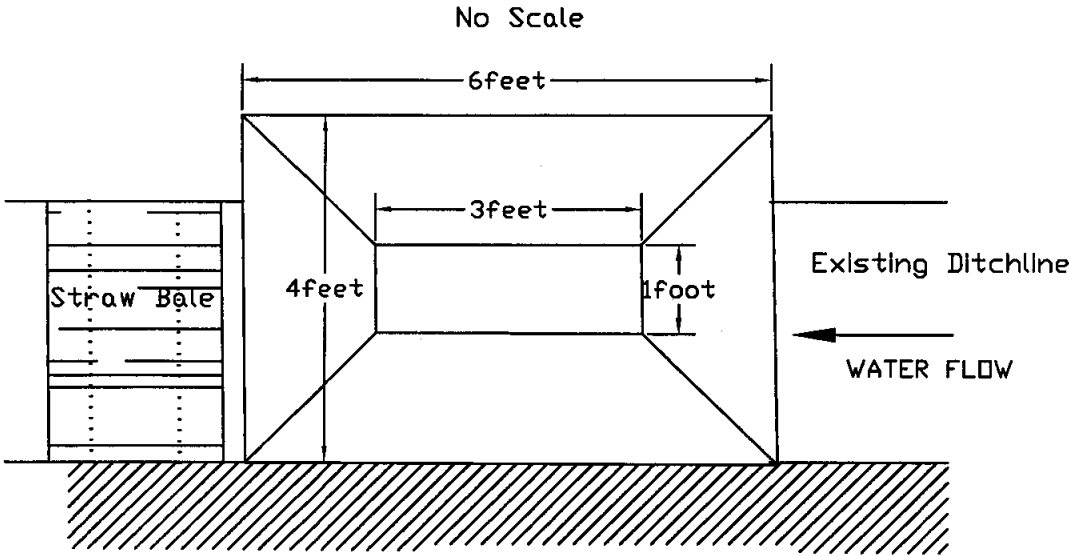

Plan View

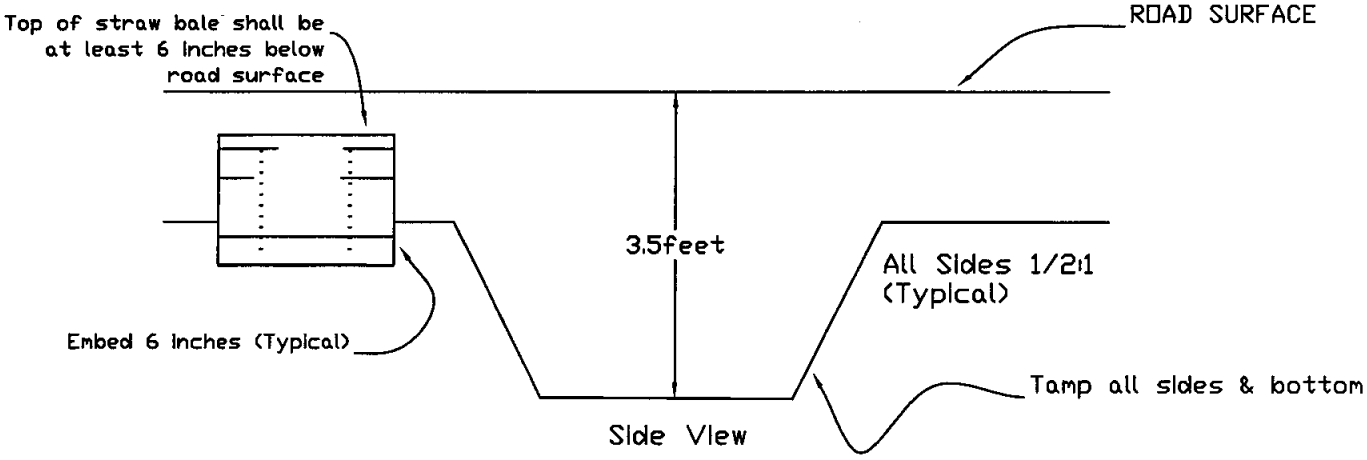

State Timber Sale Contract  
 No. 341-03-86  
 Cook East

EXHIBIT "L"  
 FILL SLOPE STABILIZATION  
 (not to scale)

A	B	C
(FEET)		
8	7	6
7	6	5
6	5	4
5	4	3
4	3	2

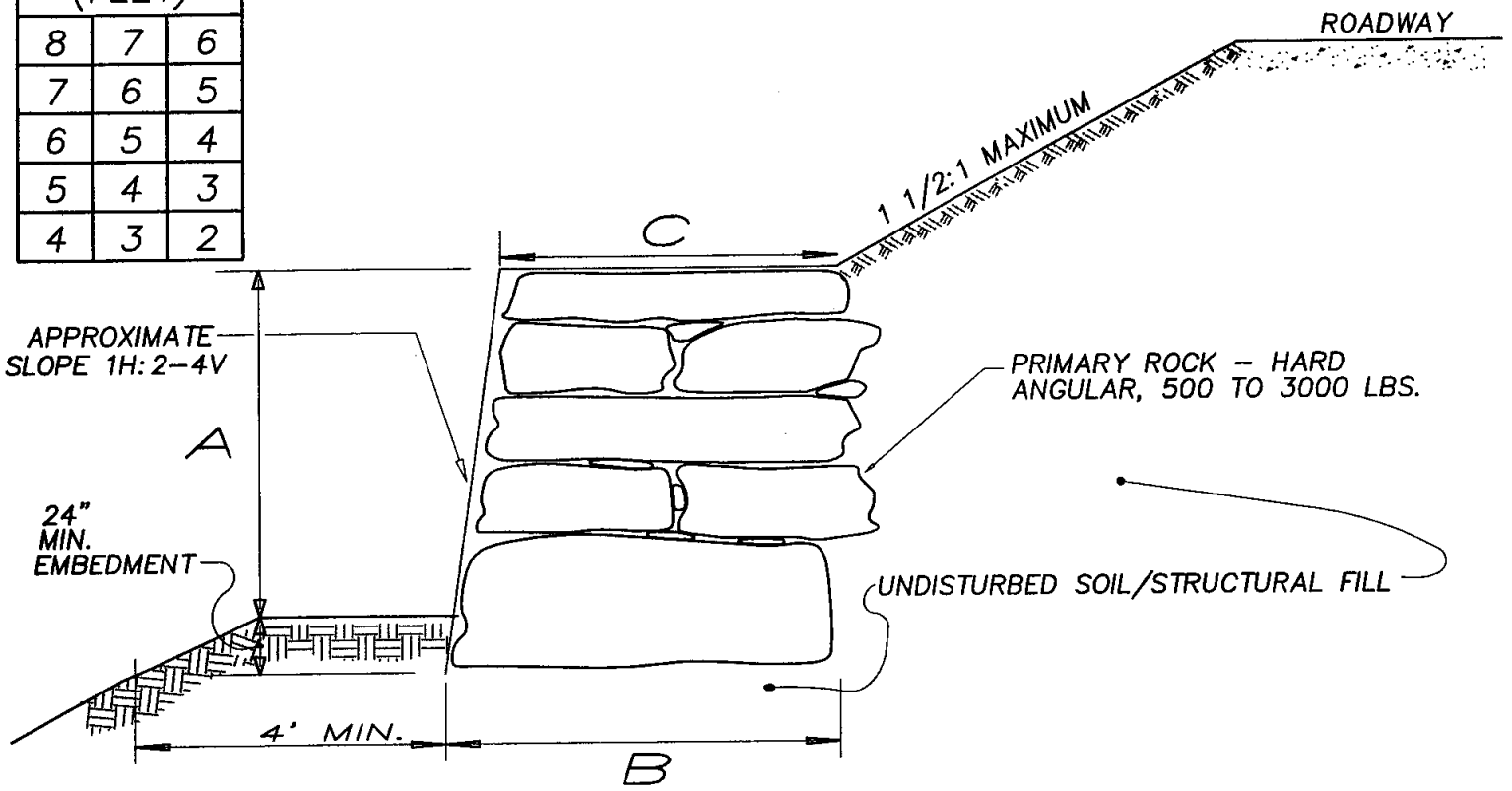

ALL ROCKS TO BE SOUND, UNWEATHERED ANGULAR ROCK. PRIMARY ROCK SHALL BE 500-3000 LBS AND SHALL NOT BE MOVABLE WITH A PRY BAR. ROCKS SHALL BE TIGHTLY NESTED (LOCKED TOGETHER) WITH ALTERNATING JOINTS AND WITH LARGER ROCKS AT BOTTOM. RIPRAP SHALL BE FREE DRAINING THROUGH SMALLER RIPRAP FILLED VOIDS. EACH ROCK SHOULD REST ON AT LEAST TWO ROCKS BELOW IT.

EXHIBIT "M"  
OREGON DEPARTMENT OF FORESTRY

SCALING INSTRUCTIONS -- LOCATION APPROVAL -- BRAND INFORMATION

(1) ORIGINAL REGISTRATION  Date \_\_\_\_\_  
 REVISION NUMBER \_\_\_\_\_  Date \_\_\_\_\_  
 CANCELLATION  Date \_\_\_\_\_

(2) TO: \_\_\_\_\_  
 (Third Party Scaling Organization)

(3) FROM: Tillamook Phone (503) 842-2545  
 (State Forestry District)

Address 5005 Third Street, Tillamook, OR 97141

(4) PURCHASER: \_\_\_\_\_  
 Address \_\_\_\_\_

(12) SALE NAME Cook East

COUNTY Tillamook

(13) STATE CONTRACT NUMBER 341-03-86

(14) SCALE: westside  eastside  cubic foot

(15) STATE BRAND REGISTRATION NUMBER \_\_\_\_\_

(16) BUREAU BRAND CODE NUMBER \_\_\_\_\_

(17) STATE BRAND INFORMATION:

(COMPLETE) ↓

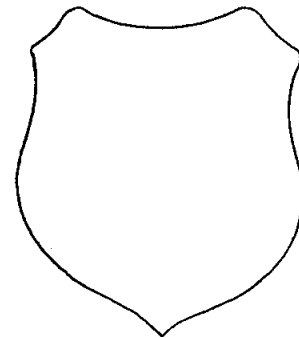

(5) MINIMUM SCALING SPECIFICATIONS			CLASS		
SPECIES	SCALING DIAMETER INCHES	*NET SCALE VOLUME	PER MBF	** SUM	SUB
Conifers	--	10	X		
Hardwoods	--	10	X		

\* Apply minimum volume test to whole logs over 40' Westside; 20' Eastside.

\*\* Sum (if indicated): see instructions and explain in Item (20).

(6) WESTSIDE SCALE: YES NO  
 Actual taper all logs over 40' scaling length

(7) EASTSIDE SCALE: YES NO  
 \*Actual taper butt logs over 40' scaling length

(8) PENCIL BUCK YES NO  
 back to Minimum Scaling Diameter \_\_\_\_\_

(9) ADD-BACK VOLUME -- YES NO  
 Deductions due to delay

(18) PAINT REQUIRED: YES   
 COLOR Orange

(19) SPECIAL SCALES
PEELABLE CULL (all species)
UTILITY/PULP (all species)
<b>NO DEDUCTIONS ALLOWED FOR MECHANICAL DAMAGE</b>
OTHER: _____
OTHER: _____

(10) APPROVED SCALING LOCATIONS	Species	Yard	Truck

(20) REMARKS: \_\_\_\_\_  
 \_\_\_\_\_  
 \_\_\_\_\_

Operator's Name (Optional inclusion by District): \_\_\_\_\_

(21) SIGNATURES:

\_\_\_\_\_  
 Purchaser or Authorized Representative Date

\_\_\_\_\_  
 State Forester Representative Date

(11) NOTICE OF CANCELLATION OF BRAND:  
 Effective Date: \_\_\_\_\_

\_\_\_\_\_  
 State Forester's Representative

## EXHIBIT "M"

## INSTRUCTIONS FOR FORM 343-307 (rev. 5/01)

- (1) Check appropriate box. REVISION NUMBER requires comments. CANCELLATION requires Item (21). Complete date.
- (2) Designate Third Party Scaling Organization (TPSO). Send 4 copies to TPSO, 1 to purchaser, 1 to Salem, and keep such copies as to district needs.
- (3) State District office, address and phone.
- (4) Enter Purchaser's business name and address as it appears on the contract.
- (5) Minimum Scaling Specifications. Review Section 45, "Log Removal," of the contract. Species, or combined species can be separate entries. Information serves as a basis for scaling (see also Items (13) thru (17)), and is required to show existence on the sale. **PerM** (per mbf). **SUM** (lump sum material). **SUB** (submerchantable material). SUB, as used by the State, references that material containing at least 10 bf (net) but less than the lower merchantable net volume limit or grade requirements for other merchantable (PerM) entries. PerM, SUM, and SUB must be indicated by checking the appropriate column. Species with the same specifications and value are combined into one entry. PerM and SUB require scaling therefore complete specifications. SUM need not be scaled, hence no specifications. Loads containing only SUM are to be ticketed if so instructed in Item (19). Mixed loads of SUM, PERM and/or SUB species will always be scaled.
- (6) Westside -- actual taper segment scale. Check Yes or No. Special Service Rules on file with TPSO. See: Segment Scaling and Grading of Long Logs -- All Species -- State Forestry Department Scaling Practices (Westside).
- (7) Eastside -- actual taper/taper table segment scale. Special Service Rules on file with TPSO. See: Segment Scaling and Grading of Long Logs -- All Species -- State Forestry Department Scaling Practices (Eastside). Items with \* follow U.S. Forest Service Eastside rules.
- (8) Pencil Buck. Check NO if a westside sale, optional for eastside sales.
- (9) Add-Back Volume. Add-Back is normally checked YES. Scaler records deductions (sap rot, weather checks, etc.) caused by an abnormal delay in removal. Enter separately on scale ticket. TPSO provides State with summaries that include this as a net volume by species. Salvage sales and certain other circumstances may require that "NO" be checked.
- (10) Show scaling locations only applicable to TPSO. Not necessary to list markets. If all species are scaled at same location, enter "ALL."
- (11) When logging is complete, recall branding hammers, date and sign where indicated, check CANCELLATION box at top of form, and send to TPSO.
- (12) Enter sale name and county.
- (13) Enter sale contract number.
- (14) Check Westside or Eastside log scale. Cubic foot refers to Northwest Log Rules Cubic Foot Scale.
- (15) Oregon Forest Products Brand Registry Number (optional).
- (16) DO NOT USE -- TPSO will fill in when applicable.
- (17) Show one brand only. Complete drawing. If more than one brand is assigned to the sale, (1) make separate form for each brand, and (2) on each form, explain and show other brand(s) under REMARKS, Item 19.
- (18) Check YES and designate orange.
- (19) Special Scales. These are the Special Scales that will be applied. If "Other" is indicated, please describe. Give comments in Item (19).
- (20) Use this space to designate weight conversion factors, or any other explanations to clarify scaling requirements. If additional scaling locations are approved, prepare another form showing all (old and new) locations. Check REVISION box at top of form and explain under remarks. Route as indicated.
- (21) Require purchaser to sign and date completed form.